

ST600R
Autopilot
Control Unit
Owner's
Handbook

Document number: 81134-3
Date: May 2001

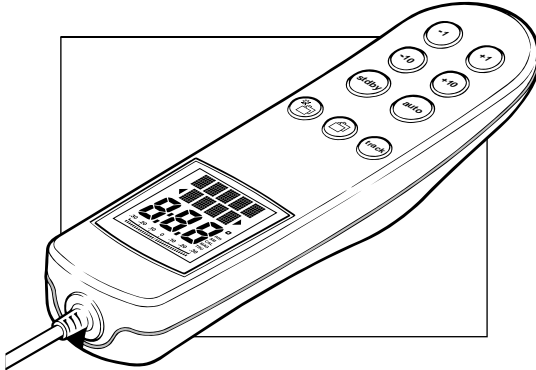

Raymarine, as part of its commitment to continuous improvement and updating, reserves the right to make changes, without prior notice, to the equipment, equipment specifications, and the instructions contained within this handbook.

To the best of our knowledge, the information contained within this handbook was correct as it went to press.

A great deal of care has been taken to ensure that this handbook is as accurate as possible. However, liability cannot be accepted for inaccuracies or omissions.

Autohelm and SeaTalk are registered trademarks of Raymarine Ltd.

WindTrim, AutoTack, AutoTrim, AutoSeastate, AutoAdapt, AutoRelease and CodeLock are trademarks of Raymarine Ltd.

Copyright © Raymarine Ltd 2001.

Preface

This handbook contains information on the operation and installation of your new equipment. In order to obtain the best performance from your autopilot, please read this handbook thoroughly.

How this Handbook is Organised

This handbook is divided into the following chapters:

Chapter 1: Introduces the autopilot, its features and its use.

Chapter 2: Covers basic autopilot operation.

Chapter 3: Explains how to use Track and Vane (WindTrim) modes and adjust autopilot performance, and summarises the ST600R alarms.

Chapter 4: Explains how to use the CodeLock security feature.

Chapter 5: Provides details on how to make adjustments to customise the autopilot to your particular vessel.

Chapter 6: Explains how to install the ST600R.

Chapter 7: Covers functional testing and initial calibration procedures after installation, and initial sea trials.

Chapter 8: Provides general maintenance procedures.

Chapter 9: Provides information to help you resolve any problems you may encounter with your autopilot.

An index is included at the end of this handbook, followed by the necessary template(s).

Warranty

To verify the ownership of your new autopilot, please take a few minutes to complete the warranty card. It is important that you complete the owner information and return the card to the factory to receive full warranty benefits.

Safety Information

Passage making under autopilot control is an enjoyable experience that can, if you are not careful, lead to the relaxation of the permanent watch. A permanent watch **MUST** be maintained no matter how clear the sea may appear to be.

Remember, a large ship can travel two miles in five minutes – just the time it takes to make a cup of coffee.

The following rules should always be observed:

- Maintain a permanent watch and regularly check all around for other vessels and obstacles to navigation – no matter how clear the sea may appear a dangerous situation can develop rapidly.
- Maintain an accurate record of the vessel's position either by use of a radio navigation receiver or visual bearings.
- Maintain a continuous plot of position on a current chart. Ensure the locked autopilot heading steers you clear of all obstacles. Make proper allowance for Tidal Set – the autopilot cannot!
- Even when your autopilot is locked onto the desired Track using a radio navigation receiver, always maintain a log and make regular positional plots. Radio navigation signals can produce significant errors under some circumstances and the autopilot cannot detect this situation.
- Make sure that all members of crew are familiar with the procedures to disengage the autopilot.

Your Raymarine autopilot will add a new dimension to your boating enjoyment. However, it is the responsibility of the skipper to ensure the safety of the vessel at all times by careful observance of these basic rules.

EMC Conformance

All Raymarine equipment and accessories are designed to the best industry standards for use in the leisure marine environment.

Their design and manufacture conforms to the appropriate Electromagnetic Compatibility (EMC) standards, but good installation is required to ensure that performance is not compromised.

Contents

Chapter 1: Introduction	1
1.1 Overview	1
1.2 Specification	2
Chapter 2: Basic Operation	3
2.1 Key Functions	3
2.2 Display Layout	4
2.3 Using Auto Mode	5
Engaging the Autopilot (Auto)	5
Disengaging the Autopilot to Return to Hand Steering	5
Changing Course in Auto Mode	6
Dodging Obstacles in Auto Mode	6
Returning to the Previous Locked Heading (LAST HDG)	7
Automatic Tack (AutoTack)	8
Off Course Alarm	9
Operating Hints	9
2.4 Manual Mode	10
2.5 Display and Keypad Illumination	11
2.6 SeaTalk Data Pages	12
Changing Chapters	12
Cycling Pages	12
SeaTalk Data Chart	13
Chapter 3: Advanced Operation	14
3.1 Operation in Track Mode	14
Initiating Track Mode	14
Automatic Acquisition	15
Manual Acquisition	16
Cross Track Error	17
Tidal Stream Compensation	18
Waypoint Arrival and Advance	18
Arrival	18
Skipping a Waypoint – SeaTalk Navigators Only	19
Advance	19
Dodges	19
Initiating a Dodge Manoeuvre	19
Cancelling a Dodge Manoeuvre	19
Safety	19
Position Confirmation at the Start of a Passage	19
Verifying Computed Positions	20
Plot Frequency	20
Setting Waypoints	20
General	20

3.2 Operation in Vane Mode (WindTrim) 20

- Selecting Vane Mode 21
- Adjusting the Locked Wind Angle 21
- Returning to Previous Apparent Wind Angle (LAST WND) .. 22
- Dodges 22
- Wind Shift Alarm 23
- Using AutoTack in Vane Mode 23
- Operating Hints 24

3.3 Adjusting Autopilot Performance 25

- Changing the Response Level (Auto Seastate) 25
- Changing the Rudder Gain 26

3.4 Alarms 26

- SeaTalk Failure 27
- No Link 27
- Auto Release 27
- Off Course 27
- Wind Shift 27
- Large Cross Track Error 27
- Drive Stopped 28
- Data Not Received 28
- Waypoint Advance 28
- Low Battery 29
- Watch Alarm 29
- Man Overboard (MOB) 29

Chapter 4: CodeLock 31

- 4.1 CodeLock Modes 31
- 4.2 Setting Up CodeLock 31
 - Initial Setup 32
 - Changing the Code or Master Unit 33
- 4.3 Entering Your Code (Manual Mode Only) 33
- 4.4 Code Number Problems 34

Chapter 5: Customising the System 35

- 5.1 User Setup 35
 - Compass Deviation Correction (SWING COMPASS) 37
 - Deviation Display (DEVIATION) 37
 - Heading Alignment (ALIGN HDG) 37
 - Pilot Type* 37
 - Heading Mode (HDG) 37
 - Bar Selection (RUDD BAR) 38
 - Rudder Calibration (DOCKSIDE RUDD CAL)* 38
 - Quitting User Setup 38
- 5.2 Dealer Setup: Type 100/300 Course Computer 39
 - Recommended Settings 41
 - Pilot Type (ST6000 Plus & Type 100/300) 42
 - Pilot Type (ST4000 Plus and ST5000 Plus) 42

Calibration Lock	42
Rudder Gain	43
Rate Level	43
Rudder Offset	43
Rudder Limit	44
Turn Limit	44
Cruise Speed	44
Off Course Alarm	45
AutoTrim	45
Power Steer	46
Drive Type	46
Rudder Damping	47
Variation	47
AutoAdapt	48
Latitude	48
Auto Tack*	49
Wind Trim*	49
Auto Release	49
Response	49
Recording Calibration Settings	50
Chapter 6: Installation	51
6.1 Planning the Installation	52
Choosing the Correct Connection Cable	52
Cabling Guidelines	52
EMC Installation Guidelines	53
6.2 Connections	54
ST1000 and ST2000 Plus Autopilot Connections	54
ST4000/5000/6000 Plus Connections	55
ST6000 & ST7000 Autopilot Connections	56
6.3 Mounting the Bulkhead Socket	56
6.4 Bulkhead Bracket Installation	58
6.5 Functional Test (Repeater Unit)	58
Switch On	59
SeaTalk Interface	59
Chapter 7: Post Installation Procedures	61
7.1 Functional Test and Initial Calibration	61
Switch On	61
Operating Sense	62
Navigation Interface (GPS, Decca, Loran)	62
Wind Transducer Interface	63
EMC Conformance	63
7.2 Initial Sea Trial	64
Automatic Compass Deviation Correction	64
Further Heading Alignment Adjustment	67
Checking Autopilot Operation	67
Checking the Rudder Gain	68

- Chapter 8: Maintenance 71**
 - General 71
 - Servicing and Safety 71
 - Advice 71
- Chapter 9: Fault Finding 72**
- Index 74**

Chapter 1: Introduction

1.1 Overview

The ST600R is a SeaTalk® compatible autopilot control unit. It is designed for use as a repeater in an autopilot system, allowing autopilot control from a secondary location, or as the control unit for a Type 100/300 Course Computer. It can also repeat instrument data in an extensive set of Data Pages.

There are five operating modes:

- Standby:** Autopilot off
- Auto:** Autopilot engaged and locked onto a heading
- Track:** Autopilot maintains a track between two waypoints created using a navigation system
- Vane:** Autopilot maintains a course relative to an apparent wind angle
- Manual:** Autopilot off during joystick control of steering

When the ST600R is being used to repeat instrument data, “pop-up pilot” pages are displayed for 5 seconds whenever a change in autopilot control is made.

The ST600R also provides the following:

- Setup and calibration options to suit each installation, giving maximum performance with many types of boat and three calibration menus (user, intermediate and dealer)
- Dockside rudder calibration feature that automatically determines the characteristics of your installation, and adjusts for them, before you set sail
- CodeLock security support
- Automatic tack facility that can be in used in Auto and Vane modes
- Automatic compass deviation correction
- Northerly/Southerly heading compensation
- Automatic heading deadband - seastate control
- Waypoint advance feature

1.2 Specification

- Power Supply: 8.5 to 16.5V DC
- Current consumption:
Standby: 60mA (less than 200mA with full lighting)
- Operating temperature: 0°C to +70°C (32°F to 158°F)
- Nine button illuminated digital keypad
- LCD display of heading, locked course and navigational data, with three levels of illumination

Chapter 2: Basic Operation

This chapter provides summary diagrams of the screen layout and key functions. It also provides instructions for engaging the autopilot and using Auto mode, changing the lighting and displaying Data Pages.

2.1 Key Functions

The autopilot is controlled using simple push-button operations, all of which are confirmed with a beep. In addition to the main single key functions, there are several dual key functions.

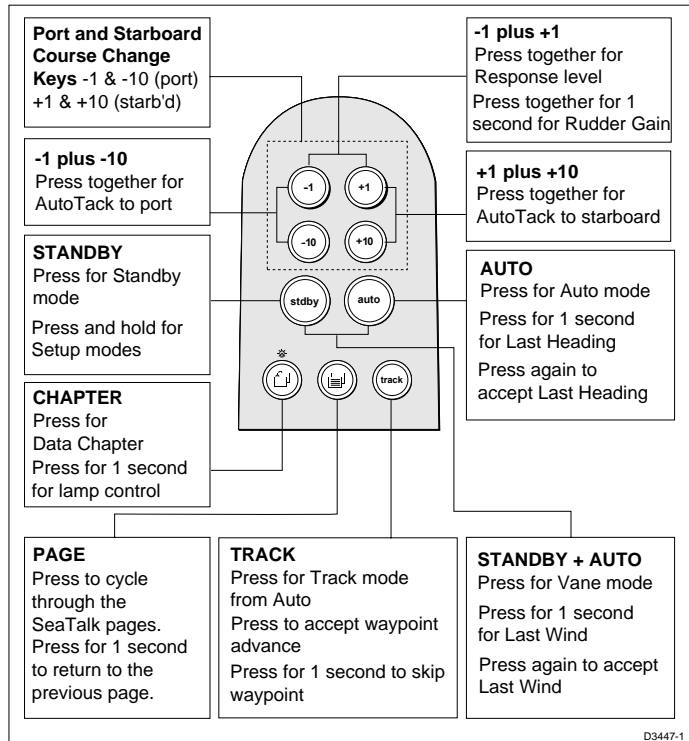

- The autopilot always powers up in Standby mode. (If the words **CODE LOCK** are displayed, enter your code as described in Chapter 4.)
- Course changes are made using the **-1**, **+1**, **-10** and **+10** keys.
- Return to manual steering at any time by pressing **STANDBY**.

2.2 Display Layout

The following illustration shows all the elements, together with a brief description, that make up the ST600R autopilot LCD display.

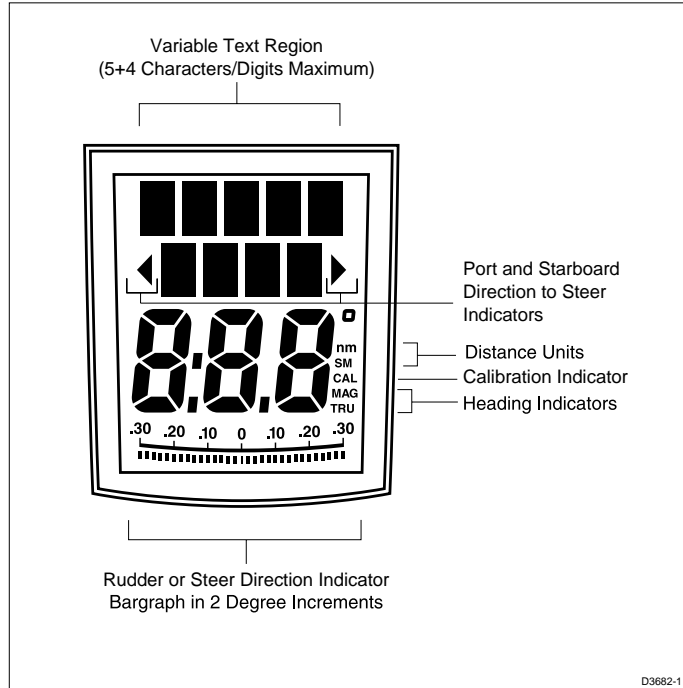

- The bar graph at the bottom of the display is normally the rudder bar. If it has been set as a direction-to-steer indicator (refer to User Setup), the display depends on the current mode (see below).

Mode	Bar
Standby	Not used (rudder angle if feedback transducer is connected to autopilot)
Auto	Heading error bar
Track	Cross track error (XTE) bar, in 0.02nm increments
Vane	Wind angle error bar

- If neither distance units (nm or SM) is displayed, the distance is in Km.

2.3 Using Auto Mode

Engaging the Autopilot (Auto)

1. Steady the vessel on the required heading.
2. Press **AUTO**.

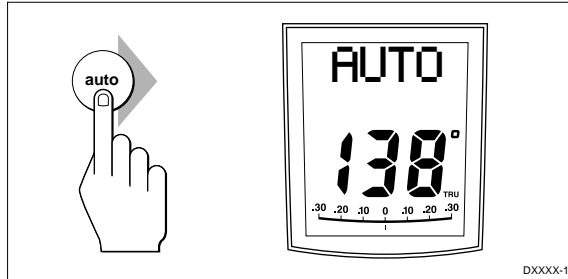

- In Auto mode, the display shows the locked autopilot heading.

Caution: **Passage making under autopilot control is an enjoyable experience that can, if you are not careful, lead to the relaxation of the permanent watch. A permanent watch MUST be maintained no matter how clear the sea may appear to be.**

Remember, a large ship can travel two miles in five minutes – just the time it takes to make a cup of coffee.

Disengaging the Autopilot (Standby) to Return to Hand Steering

- Press **STANDBY**.

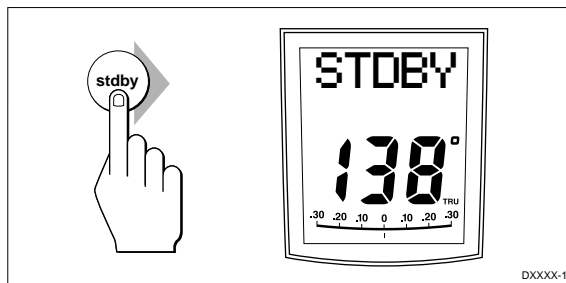

- In Standby mode, the display shows the vessel's current compass heading.
- The previous autopilot heading is memorised and can be recalled (see opposite).

Changing Course in Auto Mode

- The **+1** and **+10** (starboard) and **-1** and **-10** (port) keys are used to change the locked heading, in increments of 1° and 10°, when the autopilot has control.

Example: a 30° course change to port = press **-10** three times.

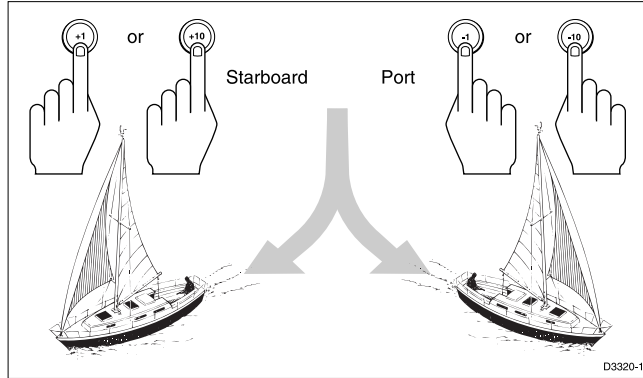

Dodging Obstacles in Auto Mode

Select a course change in the appropriate direction, for example, port 30° = **-10** three times.

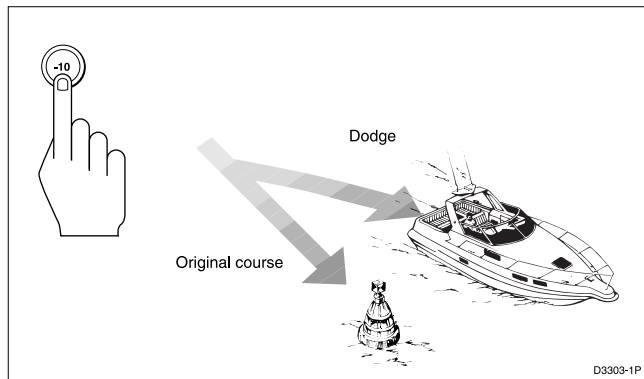

- When safely clear of the obstacle, you can reverse the previous course change (for example, press **+10** three times), or return to the previous locked heading (LAST HDG).

Returning to the Previous Locked Heading (LAST HDG)

If you steer your vessel away from the selected locked heading (for example, executing a dodge manoeuvre or selecting Standby) you can return to the previous locked heading as follows:

1. Press **AUTO** for 1 second. The previous locked heading (LAST HDG) is displayed for 7 seconds and the display flashes.

Note: A direction-to-steer indicator is displayed to show you the direction the vessel will turn.

2. To accept this heading, and resume the original course, press **AUTO** once within this 7 second period.

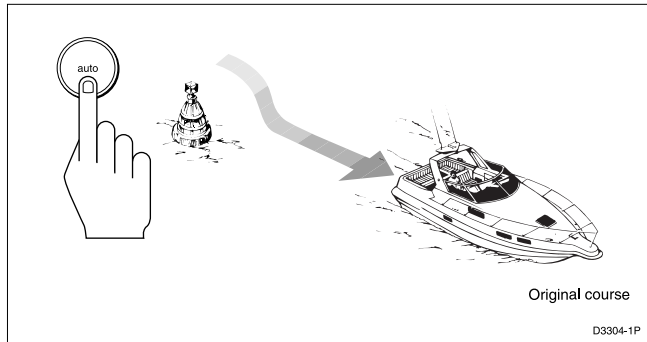

If you do not press **AUTO** while the display is flashing, the current heading will be maintained.

Automatic Tack (AutoTack)

The autopilot has a built in automatic tack facility that turns the vessel through a predetermined angle (the factory default, set in Dealer calibration, is 100°) in the required direction.

AutoTack to Starboard

- Press the **+1** and **+10** keys together to tack to starboard.

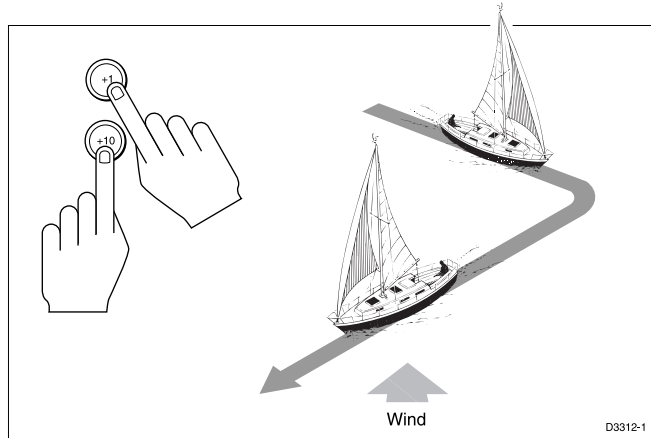

AutoTack to Port

- Press the **-1** and **-10** keys together to tack to port .

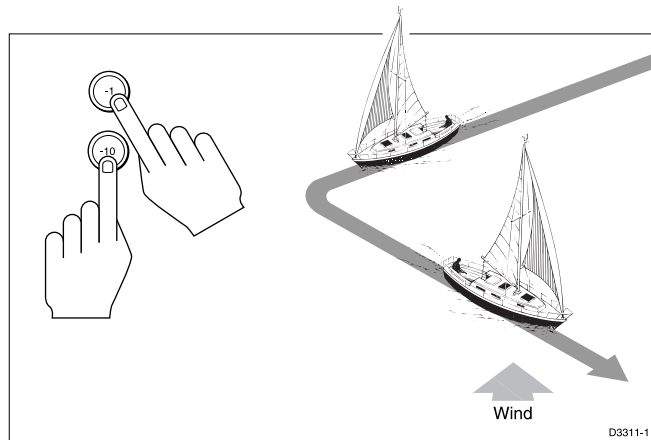

Off Course Alarm

The off course alarm sounds if the locked autopilot heading and the vessel's current heading differ for more than 20 seconds, and by more than the alarm angle set in calibration (the factory default is 20°).

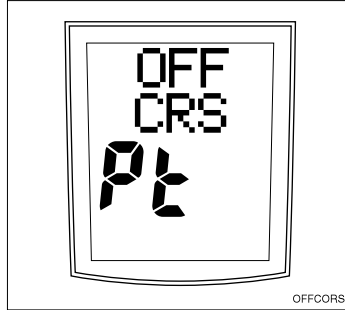

1. To cancel the off course alarm, press **STANDBY** to return to hand steering.
2. Make sure your vessel is not carrying too much sail or the sails are badly balanced. Significant improvements in course keeping can usually be obtained by improving sail balance.

Operating Hints

Making Major Course Changes

- It is sound seamanship to make major course changes only when steering manually.
- Manual course changes ensure that obstructions or other vessels are cleared properly, and due account taken of the changed wind and sea conditions on the new heading prior to engaging the autopilot.

Course Changes Under Autopilot Control

It is important to understand the effect of sudden trim changes on steering performance. When a sudden trim change occurs, due, for example, to weather helm or sail imbalance, there will be a delay before the automatic trim applies rudder to restore the locked heading. This correction can take up to one minute.

Large course changes, which change the apparent wind direction, can produce large trim changes. In these situations, the autopilot will not immediately assume the new automatic heading, and will only settle onto course when the automatic trim has been fully established.

To eliminate this problem, the following procedure can be adopted for large course changes:

1. Note the required new heading.
2. Select **STANDBY** and steer manually.
3. Bring the vessel onto the new heading.
4. Select **AUTO** and let the vessel settle onto course.
5. Bring the vessel to the final course with 1° increments.

Gusty Conditions

In gusty conditions, the course may tend to wander slightly, particularly if the sails are badly balanced. Significant improvements in course keeping can always be obtained by improving sail balance. Bear in mind the following important points:

- Do not allow the yacht to heel over excessively
- Ease the mainsheet traveller to leeward to reduce heeling and weather helm
- If necessary, reef the mainsail a little early

It is also advisable, whenever possible, to avoid sailing with the wind dead astern in very strong winds and large seas.

Ideally, the wind should be brought at least 30° away from a dead run and, in severe conditions, it may be advisable to remove the mainsail altogether and sail under headsail only.

Provided these simple precautions are taken, the autopilot will be able to maintain competent control in gale force conditions.

2.4 Manual Mode

If your system is fitted with a joystick, the ST600R will enter Manual mode when the joystick is in use.

The ST600R will return to Standby mode when the joystick button is released, or if you press the **STANDBY** key on the ST600R.

2.5 Display and Keypad Illumination

- Press  for 1 second, from any mode, to enter illumination adjustment mode and turn the lights on.

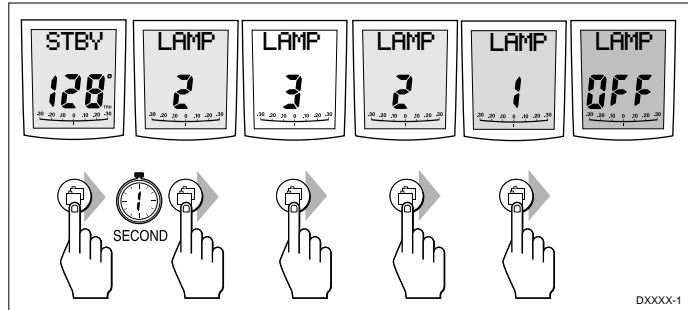

- Subsequent presses of the  key cycles the possible illumination settings: L3, L2, L1, OFF, L1, L2, L3 etc. where L3 is the brightest setting.

The display times out to normal operation after 7 seconds of keypad inactivity.

Pressing any other key before the 7 second time-out will select the mode assigned to that key (for example, **AUTO** selects Auto mode, **STANDBY** selects Standby mode).

Notes: If other SeaTalk instruments or autopilot control units are connected to SeaTalk, the illumination can be adjusted from these units.

Any adjustments to the illumination are lost when the unit is switched off.

The keys are still lit at a courtesy level when the display lighting is off.

If the illumination is initially OFF, upon entry to illumination adjustment mode the illumination is set to level 3.

2.6 SeaTalk Data Pages

The ST600R can display 21 “pages” of SeaTalk data, grouped into 6 “chapters” (see opposite page).

Changing Chapters

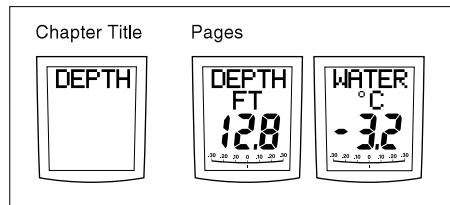

The  key is used to cycle through the chapters. The chapter title (for example, SPEED) is displayed for 2 seconds, then the first page in the chapter is displayed.

Cycling Pages



The  key is used to cycle through the pages in the current chapter.

Once a Data Page is selected, this page becomes the principle autopilot display. The autopilot mode displays (Standby, Auto, Track, Vane and Manual) then become “pop-ups”, and are displayed for 5 seconds when the autopilot mode is changed or a course change is made.

- Press  to display each Data Page in turn.
- To return to a previous Data Page, press  for 1 second. You can continue to move backwards through the Data Page sequence in this way.
- If the required data for a page is not available, dashes are displayed instead of a value.
- Most displays are repeated data and cannot be adjusted. The exceptions are the Response and Rudder Gain pages, which can be adjusted using the **+1** and **-1** keys (refer to section 3.3 for the alternative method of adjusting the Response/Gain).
- The autopilot bar graph remains in use.
- The “direction-to-steer” arrows relate to the Data Page information.

SeaTalk Data Chart

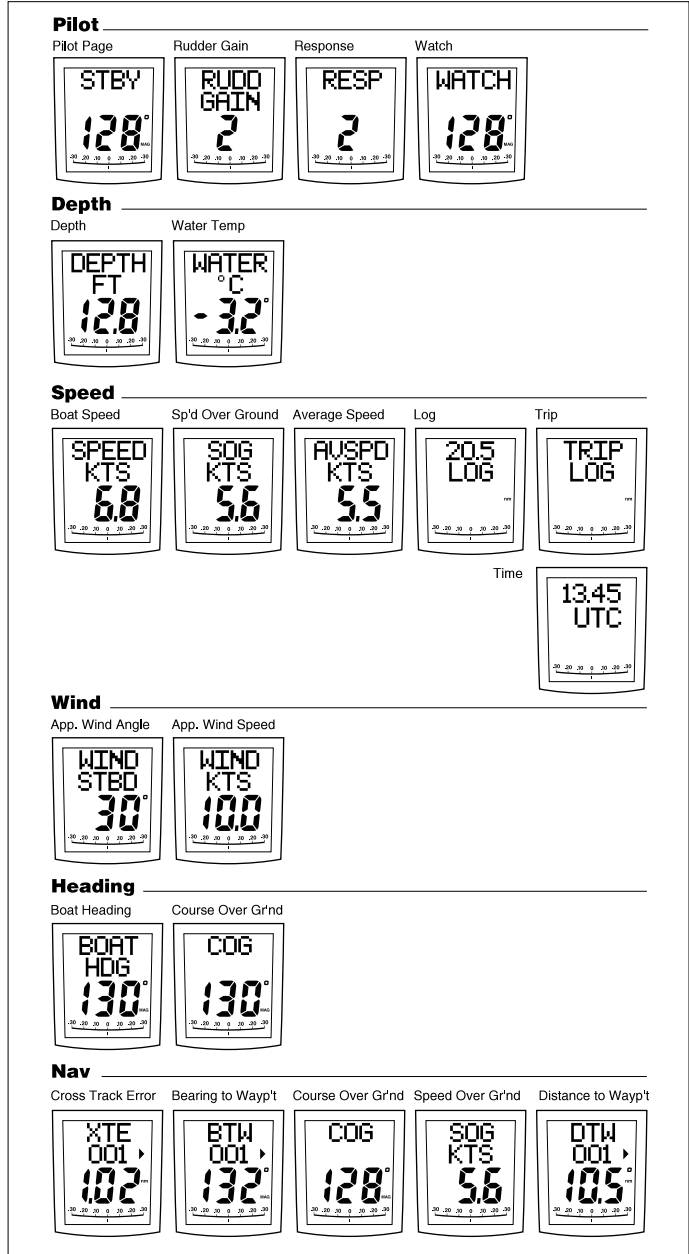

Chapter 3: Advanced Operation

This chapter provides information on:

- Operation in Track mode
- Operation in Vane mode (WindTrim)
- Adjusting response and rudder gain
- Alarms

3.1 Operation in Track Mode

Track mode is used to maintain a track between two waypoints created on a GPS, Decca, or Loran navigation system. The autopilot will then compute any course changes to keep your boat on track, automatically compensating for tidal streams and leeway.

The autopilot can receive cross track error (the distance your vessel is from a planned track) from a SeaTalk navigation instrument or chartplotter

Track mode is selected by pressing the **TRACK** key, but can only be selected in Auto mode. You can return to either Auto or Standby from Track as follows:

- Press **AUTO** to leave Track mode and return to Auto mode.
- Press **STANDBY** to leave Track mode and return to manual steering.

Initiating Track Mode

When initiating Track mode, the track can be acquired in one of two ways:

- Automatic acquisition – when cross track error and bearing to waypoint data are available
- Manual acquisition – when cross track error is the only available data

Automatic Acquisition

Automatic acquisition can only be achieved if the pilot is receiving cross track error and bearing to waypoint information (via SeaTalk or NMEA 0183). It is initiated as follows:

1. Bring the vessel to within 0.1nm of track
2. Press **AUTO**.
3. Press **TRACK** to enter Track mode, with the current locked heading displayed.

After a short delay for data acquisition, the Waypoint Advance alarm will sound, and the display will show the planned bearing to waypoint alternating with the direction in which the boat will turn.

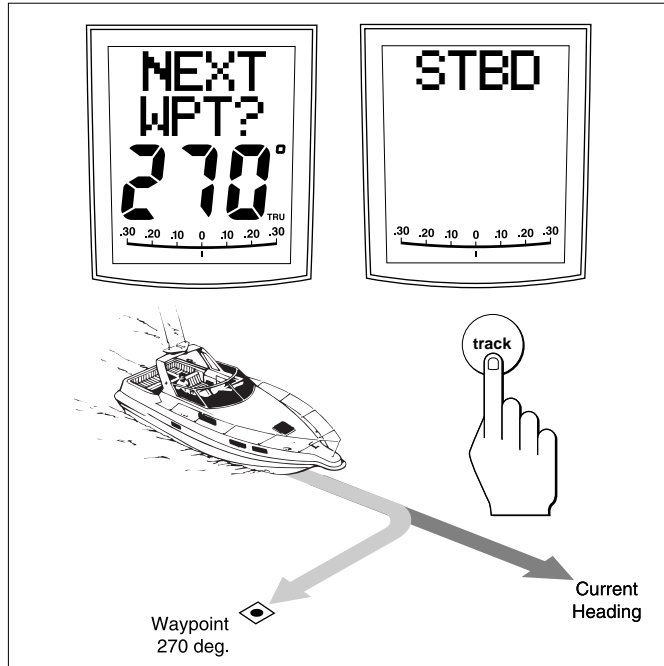

Note: If the vessel is further than 0.3nm from the track, the Large Cross Track Error alarm will sound. Press **STANDBY** to cancel the alarm, hand steer closer to the track, and press **AUTO** and **TRACK** again.

4. Check that it is safe to turn onto the new course.
5. Press the **TRACK** key. The boat will turn on to the new course and the alarm will be cancelled.

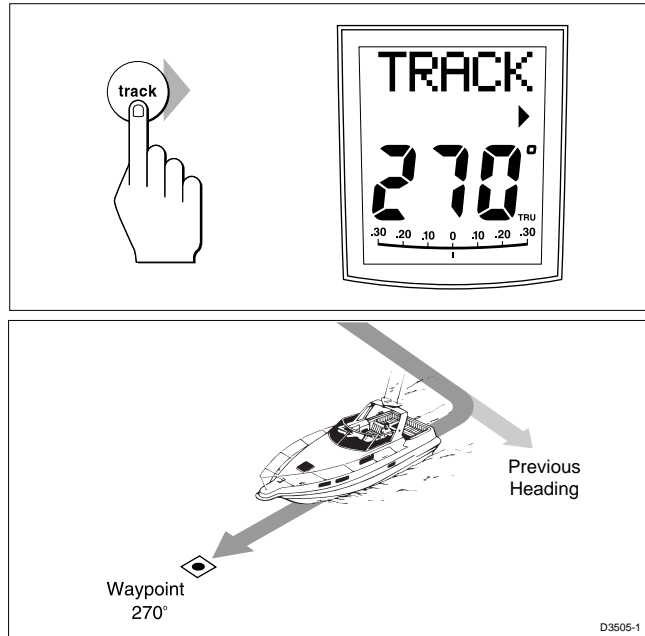

- The display shows the new bearing to waypoint.

Manual Acquisition

For manual track acquisition when cross track error is the only data available:

1. Steer the vessel to within 0.1nm of track.
 2. Bring the heading to within 5° of the bearing to the next waypoint.
 3. Press **AUTO**.
 4. Press **TRACK** to enter Track mode.
- The display shows the cross track error and the locked pilot heading.

Note: At low speeds, the effect of tidal streams is far more significant than it is at higher speeds. Providing the tidal flow is less than 35% of the vessel's speed, no noticeable difference should occur in the performance of Track mode. However, extra care should be taken during manual acquisition, as follows:

- Ensure that the vessel is as close as possible to track, and the direction made good over the ground is as close as possible to the direction of the next waypoint, before selecting Track mode.
- Make positive positional checks at regular intervals, especially if navigational hazards are close by.

Cross Track Error

Cross track error (XTE) is the distance between the current position and a planned route. This is displayed in nautical miles (nm), statute miles (SM) or kilometres, and is taken directly from your navigator.

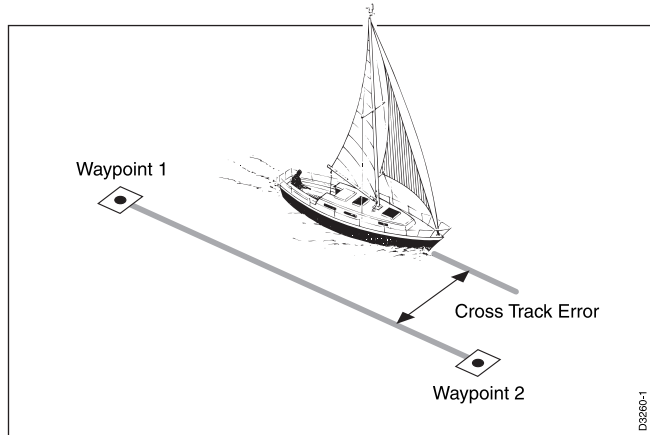

The Large Cross Track Error alarm sounds if the cross track exceeds 0.3nm.

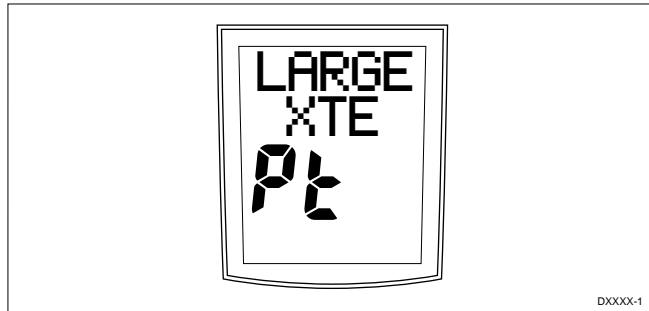

- The direction of the error is identified as “**Pt**” port or “**Stb**” starboard.
- To cancel the alarm, press **STANDBY** to return to hand steering, or **AUTO** to return to Auto mode.

Note: If the Large Cross Track Error alarm sounds, it is usually an indication that the cross tide is too great for the vessel's current speed.

Tidal Stream Compensation

Under most conditions, Track mode will hold the selected track to within $\pm 0.05\text{nm}$ (300ft) or better.

The autopilot takes account of vessel speed when computing course changes to ensure optimum performance over a wide range of vessel speeds. If speed data is available, the autopilot uses the measured vessel speed. Otherwise, the Speed Over Ground (SOG) or specified cruise speed is used, depending on the calibration setting (see “Dealer Setup” in Chapter 5).

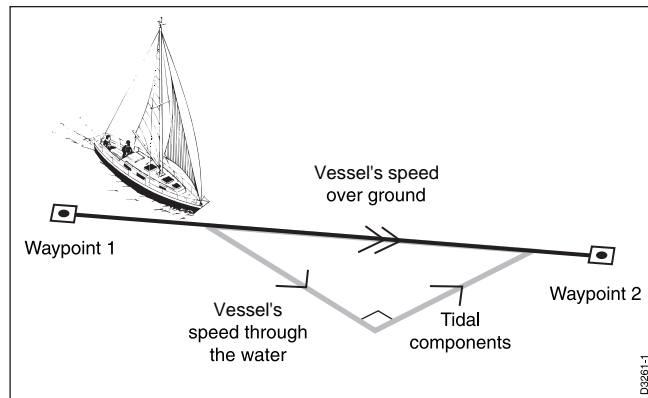

Waypoint Arrival and Advance

If your navigation receiver transmits valid NMEA waypoint number and bearing to waypoint data, it is possible to advance from one waypoint to the next by simply pressing **TRACK**.

Arrival

As the vessel passes the target waypoint, the navigation receiver should select (manually or automatically) the next target waypoint.

The autopilot detects the new target waypoint number, sounds the Waypoint Advance alarm and displays the Waypoint Advance information. This display shows the new bearing to waypoint and the direction the boat will turn to acquire the new track.

To accept the new target waypoint, press **TRACK**.

Skipping a Waypoint – SeaTalk Navigators Only

If you wish to advance to the next waypoint before you have arrived at the target waypoint, press **TRACK** for 1 second. The Waypoint Advance information for the next waypoint is displayed.

Advance

While the waypoint advance alarm is sounding, Track mode is suspended and the autopilot maintains the current boat heading.

1. Check that it is safe to turn onto the new track.
2. Press the **TRACK** key. This will cancel the waypoint arrival alarm and turn the boat towards the next waypoint.

Unless the Waypoint Advance is accepted in the above manner, the alarm will continue to sound and the current heading will be maintained.

Dodges

Full control is still available from the keypad when the autopilot is in Track mode.

Initiating a Dodge Manoeuvre

In track mode, dodge manoeuvres are accomplished by simply selecting the desired course change using the course change keys (**-1, +1, -10 or +10**).

Cancelling a Dodge Manoeuvre

Once the hazard has been avoided, the course change selected for the dodge manoeuvre should be cancelled by selecting an equal course change in the opposite direction.

Note: Provided the vessel remains within 0.1nm of track, there is no need to steer back towards the track.

Safety

Passage making in Track mode removes the chores of compensating for wind and tidal drift, and will aid precise navigation. However, it is important to maintain an accurate log with regular plots.

Position Confirmation at the Start of a Passage

At the start of a passage you must always confirm the fix given by the position transducer, using an easily identifiable fixed object. Check for fixed positional errors and compensate for them.

Verifying Computed Positions

- Verify the computed position with a dead reckoned position, calculated from the average course steered and the distance logged.

Plot Frequency

- In open water, plots should be at least hourly.
- In confined waters, or when potential hazards are near, plots should be more frequent.
- Local variations in radio signal quality, and changes in the tidal stream, will produce deviations from the desired track.

Setting Waypoints

- When setting waypoints, remember that deviations will occur.
- Thoroughly check along each track.
- Check up to 0.5nm each side of the track to ensure that there are no hazards within the zone.

General

The use of track mode will enable accurate track keeping even in complex navigational situations. However, it cannot remove the responsibility of the skipper to ensure the safety of his vessel at all times by careful navigation and frequent position checks.

3.2 Operation in Vane Mode (WindTrim)

Vane mode, also known as WindTrim, allows the autopilot to maintain a course relative to an apparent wind angle. It uses wind trim to eliminate the effects of turbulence and short term wind variations, and provides smooth precise performance under Vane mode operation with minimal power consumption.

Vane mode uses the fluxgate compass as the primary heading reference and, as changes in the apparent wind angle occur, the locked compass heading is adjusted to maintain the original apparent wind angle.

To use Vane mode, the autopilot must receive wind information from one of the following sources:

- SeaTalk Wind instrument, connected to the autopilot via SeaTalk
- NMEA wind information
- Raymarine wind vane connected to a SeaTalk interface box

Selecting Vane Mode

Vane mode can be selected from either Standby or Auto modes, as follows:

1. Steady the vessel onto a heading at which the apparent wind angle is close to angle you require.
2. Press **STANDBY** and **AUTO** together to select Vane mode and lock the current apparent wind angle.

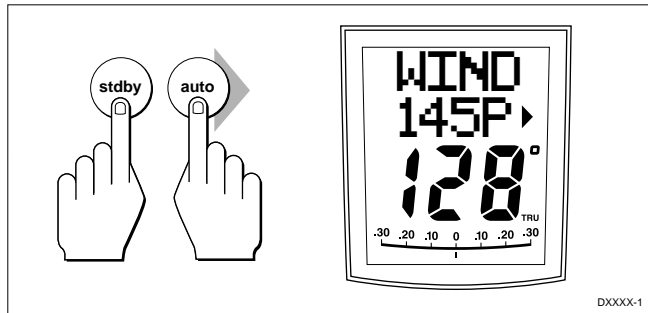

- The locked heading is displayed in large characters. The locked apparent wind angle is displayed above the heading, with an **P** (port) or **S** (starboard) direction indicator.
- The boat heading is adjusted by the autopilot to maintain the locked apparent wind angle.

Adjusting the Locked Wind Angle

The locked wind angle can be adjusted by changing course using the **-1**, **+1**, **-10** and **+10** keys.

For example, to bear away by 10° when the vessel is on starboard tack, press **-10** to turn the vessel 10° to port. The locked apparent wind angle and locked heading both change by 10° . The new apparent wind angle is maintained, and the locked heading adjusted by the autopilot as required.

Note: This method does not apply to systems using the Type 100/300 Course Computer. Also, this method should only be used for minor adjustments to the apparent wind angle, since turning the boat affects the relationship between the true and apparent wind angles. For major changes, return to Standby mode, steer onto the new heading, and reselect Vane mode.

Returning to the Previous Apparent Wind Angle (LAST WND)

If for any reason the vessel is steered away from the selected apparent wind angle (for example, a dodge manoeuvre or selecting Standby) you can return to the previous locked wind angle:

1. Press **STANDBY** and **AUTO** together for 1 second to display the previous apparent wind angle (LAST WND).

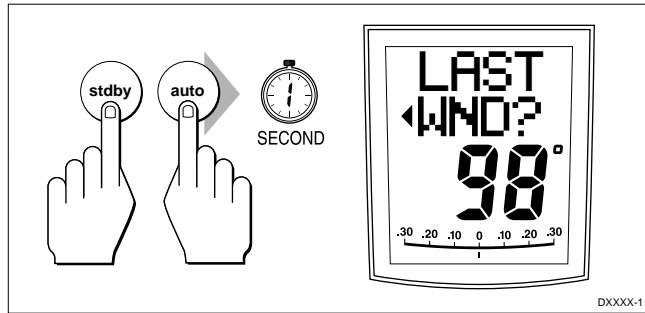

The LAST WND? text alternates with the previous wind angle and direction. The previous locked heading is displayed, with an indicator to show you the direction in which the vessel will turn.

2. Check that it is safe to turn on to this course.
3. To accept this apparent wind angle, press **STANDBY** and **AUTO** together within 7 seconds.

If you do not accept the previous wind within this time, the autopilot will lock on to the current apparent wind angle.

Dodges

Full control is still available from the keypad when the autopilot is in Vane mode.

- Dodge manoeuvres are accomplished by simply selecting the desired course change using the course change keys (-1, +1, -10 or +10). Both the locked heading and locked apparent wind angle are adjusted.
- Once the hazard has been avoided, you can reverse the previous course change, or return to the previous apparent wind angle (LAST WND).

Wind Shift Alarm

The wind shift alarm sounds, and the text “WINDSHIFT” is displayed, if a wind shift of more than 15° is detected.

1. Press **STANDBY** to cancel the alarm and return to hand steering, and steer onto the required heading.
2. Press **STANDBY** and **AUTO** together to return to Vane mode with the new apparent wind angle.

Using AutoTack in Vane Mode

The automatic tack function, when used in Vane mode, turns the vessel so that the locked apparent wind angle is changed to an equal angle on the opposite bow.

Initially, the autopilot turns the vessel through the specified tack angle (the factory default is 100°). Then the locked heading is adjusted until the required apparent wind angle is achieved.

- To tack to starboard, press the **+1** and **+10** keys together.
- To tack to port, press the **-1** and **-10** keys together.

Note: If you use the Autotack function in Vane mode, it is important to check that the wind vane has been centred accurately when it was installed. **Also, the AutoTack feature cannot be adjusted if you are using a Type 100/300 Course Computer.**

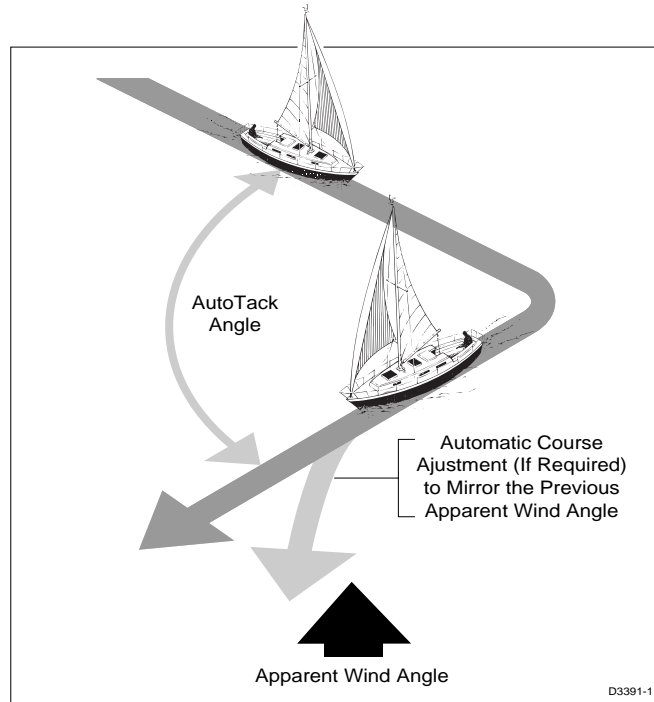

Operating Hints

- Major changes to the selected apparent wind angle should be made by returning to Standby mode, changing course manually, then reselecting Vane Mode.
- Vane mode filters the windvane output. This provides the optimum response for off-shore conditions where genuine shifts in wind direction occur gradually.
- In gusty and unsteady inshore conditions, it is best to sail a few degrees further off the wind so that changes in apparent wind direction can be tolerated.
- It is important to ensure that the amount of standing helm is minimised by careful sail trimming and positioning of the mainsheet traveller.
- The headsail and mainsail should be reefed a little early rather than too late.

3.3 Adjusting Autopilot Performance

The response level and rudder gain can be adjusted during normal operation using a combined key-press.

The default calibration settings for response and rudder gain (refer to Dealer Setup) are restored when the system is powered on.

Changing the Response Level (Auto Seastate)

The response level controls the relationship between the autopilot's course keeping accuracy and the amount of helm/drive activity.

- **Response Level 1**, Auto Seastate (Automatic Deadband), causes the autopilot to gradually ignore repetitive movements of the vessel and only react to true variations in course. This provides the best compromise between power consumption and course keeping accuracy, and is the default calibration setting.
- **Response Level 2** (Minimum Deadband) provides the tightest course keeping possible. However, tighter course keeping results in increased power consumption and drive unit activity.
- **Response Level 3** (also Minimum Deadband) provides the tightest course keeping possible by introducing yaw damping (requires a rate gyro and is only available with course computer systems).

The response can be changed at any time. To do so:

1. Press the **+1** and **-1** keys together momentarily to display the Response screen.
2. Press **+1** or **-1** to change the response level.
3. Wait for 5 seconds, or press , to return to the previous display.

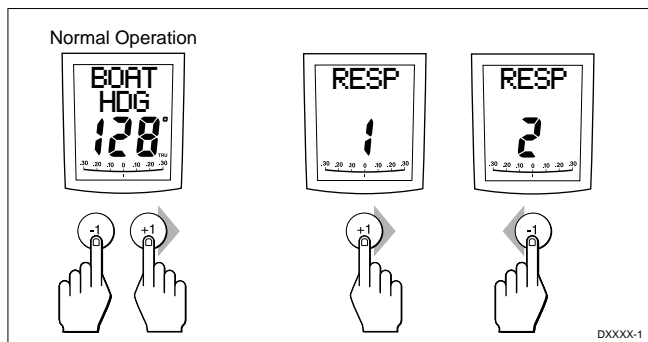

Changing the Rudder Gain

Press the **+1** and **-1** keys together for 1 second to display the Rudder Gain screen, and adjust the setting in the same way as for the response level. Refer to Chapter 7, “Post Installation Procedures”, for instructions on how to check that the rudder gain is set correctly.











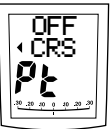

Warning: **It is important that the rudder gain is correctly set on planing craft. Incorrect adjustment will lead to poor steering performance and is dangerous at high speeds.**

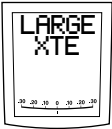
3.4 Alarms

This section summarises the alarms (in order of priority) that are reported by the ST600R.

Press **STANDBY** to clear an alarm and return to hand steering, unless indicated otherwise.

Alarms

SeaTalk Bus Failure 	No Link to Course Computer 	Automatic Release 	Off Course (port or starboard) 
Shift in Wind Direction 	Large Cross Track Error 	Drive Stopped 	Data not Received 
Next Waypoint 	Low Battery Voltage 	Silent Watch 	Watch 
Shallow Alarm 			

SeaTalk Failure

This silent alarm indicates that there is a wiring fault in the SeaTalk connection.

No Link

This silent alarm indicates that there is no link between the ST600R and the course computer.

Auto Release

The Auto Release alarm is activated when an Raymarine stern drive actuator is returned to manual steering.

Off Course

This alarm is activated when the vessel has been off course from the locked heading by more than the specified angle for more than 20 seconds (see Section 2.3, “Using Auto Mode”).

The alarm is cleared if the heading recovers or the course is changed, or if the operating mode is changed.

Wind Shift

This alarm is activated when the apparent wind angle requires an adjustment of the locked heading by more than 15° (see Section 3.2, “Operation in Vane Mode”).

Large Cross Track Error

This alarm is activated when the cross track error exceeds 0.3nm (see Section 3.1, “Operation in Track Mode”).

The autopilot stops controlling the locked heading as soon as this condition occurs.

The alarm is cleared if the heading recovers or the course is changed, or if the operating mode is changed.

Drive Stopped

This alarm is activated if the autopilot is unable to turn the rudder. This occurs if the weather load on helm is too high, or if the requested rudder position is past the preset rudder limits or the rudder end-stops.

Data Not Received

This alarm is displayed in the following circumstances:

- Track mode is engaged and the autopilot is not receiving SeaTalk navigation data.
- Track mode is engaged and the position transducer (GPS, Loran, Decca) is receiving a low strength signal – this will clear as soon as the signal strength improves.
- Vane mode is engaged and the autopilot has not received wind angle data for 30 seconds.

The autopilot stops adjusting the locked heading as soon as data is lost.

Waypoint Advance

The waypoint advance alarm sounds whenever the target waypoint number changes, which occurs in the following circumstances:

- Automatic acquisition is selected by pressing **TRACK** from Auto mode
- Waypoint advance is requested by pressing **TRACK** for 1 second in Track mode (SeaTalk Navigators only).

When the alarm sounds, the pilot continues on its current heading, but displays the bearing to the next waypoint and the direction in which the boat will turn to take up that bearing.

Check that it is safe to turn onto the new track, and press **TRACK** to accept the waypoint advance.

To cancel the alarm without accepting the waypoint advance, press **STANDBY** to return to hand steering, or **AUTO** to return to Auto.

Note: The waypoint advance will only operate on pilots receiving valid bearing to waypoint and waypoint number information.

Low Battery

The Low Battery alarm sounds when the supply voltage drops below 10V ($\pm 0.5V$).

Press **STANDBY** to clear the alarm and return to hand steering.

Start the engine to recharge the battery.

Watch Alarm

The Watch alarm is activated in Watch mode when the timer Page is displayed.

- The watch timer starts counting.
 - When the timer reaches 3 minutes, the text on the display starts flashing to indicate the last minute of Watch alarm.
 - When the timer reaches 4 minutes, the audible Watch alarm is activated.
3. Press **AUTO** at any time to silence the alarm and reset the timer to 4 minutes (Pressing any other key resets the timer and performs the key's normal function).
 4. To clear Watch mode, press  to display the PILOT page.

Note: Watch mode is also cleared if the chapter is changed or a pilot mode change occurs.

Man Overboard (MOB)

If a man overboard (MOB) message is received from another instrument on the SeaTalk system, the text "MOB" is shown instead of the waypoint number for the XTE, DTW and BTW Data Pages.

If the autopilot is operating in Track mode, the Waypoint Advance alarm will sound to notify the change in waypoint.

Chapter 4: CodeLock

CodeLock is a personal four-digit security feature designed to protect your valuable instruments against theft. You don't have to activate the system, but it's there if you need to. You can activate it using any CodeLock-compatible control unit on your SeaTalk system.

When you first enter a code and activate CodeLock, the code is sent to all the CodeLock-compatible units on the system. After this, whenever you power on the system, the units will only start up if they receive the correct code.

Remember to fix a CodeLock sticker by each instrument, to deter potential thieves.

4.1 CodeLock Modes

When you set up CodeLock, you can choose whether the code will be sent automatically or must be entered manually at power on, as follows:

- **Auto** mode is used when there is a display unit situated in a secure location, ideally below deck, or one which can be unplugged and removed to a secure location. You enter your chosen code on this "master" unit when you first activate CodeLock. This code is then automatically sent to all CodeLock-compatible display heads on SeaTalk, without further intervention, every time the system is powered on.
- **Manual** mode is used to provide a higher degree of security, perhaps when all your instruments are mounted in exposed locations. In this case, you must enter your personal code every time the system is switched on. The code can be entered into any convenient CodeLock-compatible control unit, and is then sent to all the other compatible units via SeaTalk.

4.2 Setting Up CodeLock

CodeLock is set on the ST600R using the Intermediate Setup options.

Initial Setup

When you first install your ST600R, CodeLock is set OFF. To activate CodeLock, refer to the following flow diagram.

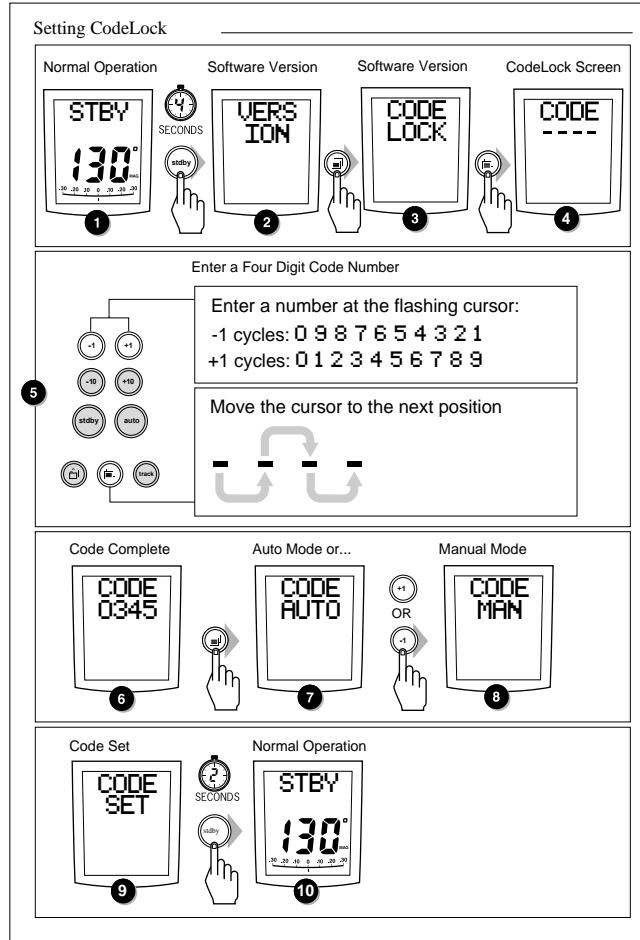

- Make sure that the autopilot is in Standby mode before accessing Intermediate Setup.
- If the CAL LOCK screen is displayed instead of the VERSION screen, you need to turn off the lock feature in Dealer Setup.

The Intermediate Setup displays have the following functions:

- **Manual/Auto** modes are explained in section 4.1
- **Version numbers:** Displays the current ST600R version number, alternating with the ST60 pilot version number (if applicable). You cannot adjust these displays.
- **CodeLock status:** Reports the current status, which can be OFF or SET. You cannot adjust this display directly.
- **CodeLock entry:** Used to enter a new code if CodeLock is OFF, or to turn CodeLock off if it is already set.
- **CodeLock mode:** Used to select Auto or Manual CodeLock mode, when a new code has been entered.

Changing the Code or Master Unit

You can change the code from any CodeLock compatible control unit on your SeaTalk system, provided you know the current code.

Note: If you set up CodeLock in Auto mode, the unit on which you enter the new code becomes the new master unit.

To change the code:

1. Display the CodeLock entry screen and enter your current code, as shown in the flowchart.

The code is checked. If it is incorrect, the four dashes are redisplayed and you must enter the code again. If it is correct, the CodeLock status screen is displayed, with the status set to OFF.
2. Press  to display the CodeLock entry screen again.
3. Enter the new code (as described in Initial Setup) and move on to the CodeLock mode selection screen.
4. Set the mode to Auto or Manual, as required.
5. Press and hold **STANDBY** for 2 seconds to exit Intermediate Setup and save the new settings.

4.3 Entering Your Code (Manual Mode Only)

If CodeLock has been set up in Manual mode, the correct code must be entered on one of the control units every time the system is switched on. The code number created on the master is entered via the keypad from any CodeLock-compatible instrument, and this code is then sent to all compatible instruments on the same SeaTalk bus. Once this code has been received the instruments operate in the normal way.

To enter your chosen code number on the ST600R control unit, use the keys as shown.

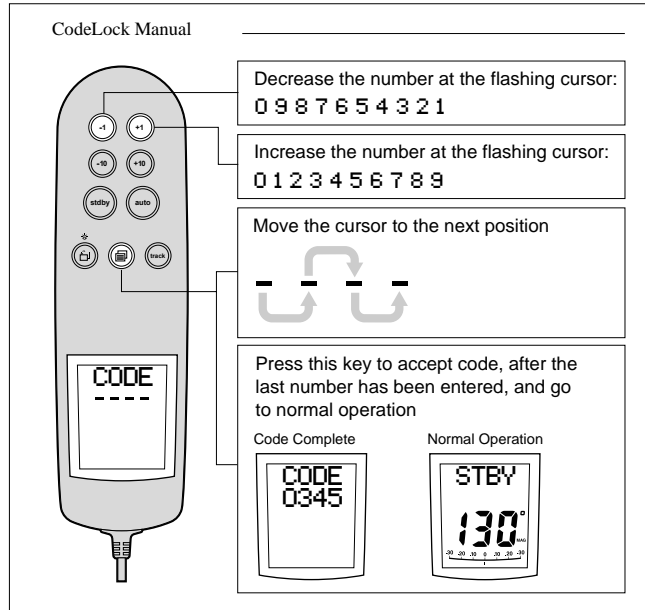

To enter the code on any other master display unit, refer to the handbook for that unit for details of the code entry procedure.

4.4 Code Number Problems

- If an incorrect code number has been entered, the four dashes are redisplayed, with the prompt “code”. Repeat the procedures illustrated above entering the correct four digit number.
- If you forget your code number, you must take your master unit to an authorised dealer, together with appropriate proof of ownership such as the original invoice. The dealer will be able to reset the unit so that you can enter a new code.

Chapter 5: Customising the System

The ST600R provides setup and configuration options that are used to adjust the settings for the ST600R itself, the compass, and the autopilot.

Note: You should perform the post installation procedures described in Chapter 7 before adjusting any other calibration features.

There are three setup levels:

- **User Setup**, which controls compass setup, rudder calibration and the ST600R display features
- **Intermediate Setup**, which controls the CodeLock security feature and displays status and version number information (see Chapter 4)
- **Dealer Setup**, which controls the autopilot settings, and also the calibration lock which can be used to prevent accidental access to User and Intermediate Setup

The Dealer Setup options described in this chapter only apply if you have installed the ST600R as the control unit for a Type 100/300 course computer. If you have installed the ST600R as a repeater unit on an autopilot system, please refer to the Dealer Setup instructions in the handbook for the main control unit.

5.1 User Setup

The flow chart on the following page shows the User Setup control procedure, and the setup screens with their default settings. Information on the functions of the different settings is given in the remainder of this section.

The following points should be considered:

- Make sure that the autopilot is in Standby mode before you access User Setup
- If the CAL LOCK screen is displayed instead of the initial page, you need to turn off the lock feature in Dealer Setup
- Setup options are always saved on exit

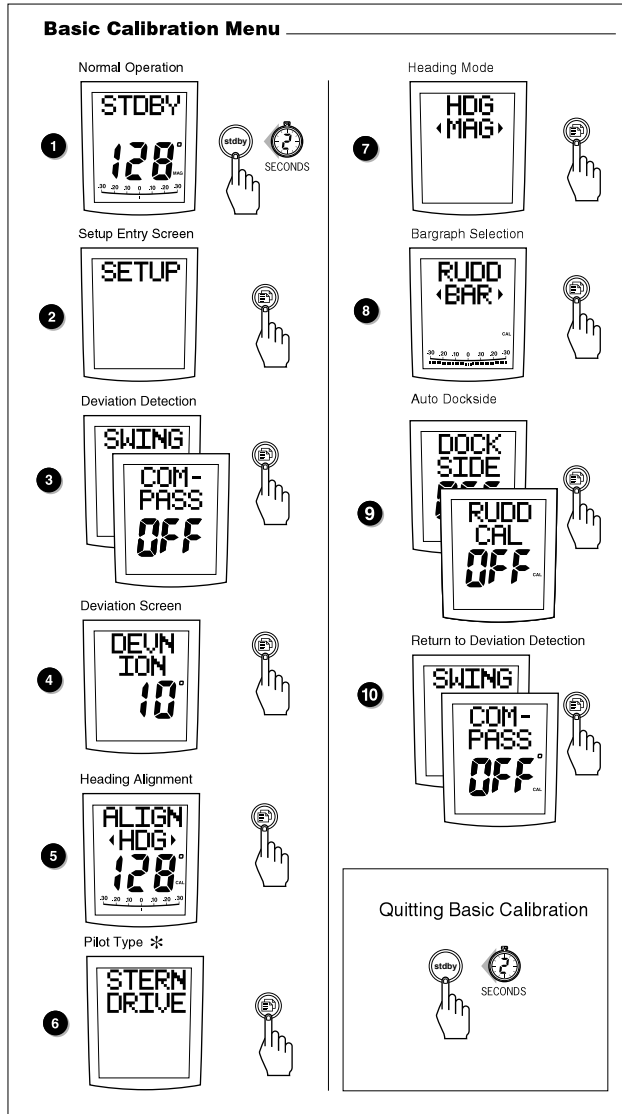

* Not applicable to pre version 11 Type 100/300 Course Computer software

Compass Deviation Correction (SWING COMPASS)

The compass deviation correction option allows you to correct the compass for deviating magnetic fields. The procedure must be performed as the first item in your initial sea trial, and is described in detail in Chapter 7, “Post Installation Procedures”.

Deviation Display (DEVIATION)

This screen shows the current deviation value, calculated from the correction procedure (Swing Compass). You cannot edit this value.

Heading Alignment (ALIGN HDG)

The heading alignment screen shows the current reported heading.

Note: You should always check the compass alignment after performing a compass deviation correction (see “Post Installation Procedures”). However, once the initial correction procedure has been performed, you can make adjustments to the alignment as often as you wish, without re-correcting your compass.

- Steer onto a known heading, and check the heading displayed.
- If required, adjust the heading value to match the known value, using the **+1**, **-1**, **+10** and **-10** keys.

Pilot Type*

Displays the Pilot Type: sterndrive, displacement, semi-displacement or planing.

Heading Mode (HDG)

Select either magnetic or true heading mode, using the **+1** or **-1** key. When heading data is displayed in normal operation, the screen indicates whether true or magnetic mode has been selected.

Bar Selection (RUDD BAR)

Select the type of bar graph, using the **+1** or **-1** key, to be shown at the bottom of the SeaTalk displays.

The options are as follows:

RUDD BAR: This shows the rudder position, and is the default setting. Note that a rudder reference transducer is required for accurate rudder position information.

STEER BAR: The bar graph is used as follows:

Mode	Bar
Standby	Not used (shows rudder angle if a feedback transducer connected to the autopilot)
Auto	Heading error bar
Track	XTE bar
Vane	Wind angle error bar

Rudder Calibration (DOCKSIDE RUDD CAL)*

Dockside Rudder Calibration is used to automatically calibrate the rudder range (for systems with a rudder reference unit) and optimise autopilot performance by matching the autopilot to its installation.

Warning: **This procedure moves the helm, and should only be used when the vessel is at the dockside. For sterndrive systems, the engines must be running before you start the procedure.**

- The auto dockside procedure is not available if the ST600R is used with a Type 100/300 Course Computer.
- The Dock Side calibration feature is started using the **+1** or **-1** key.
- If you start the procedure by mistake, press any key to cancel it.
- If the autopilot does not respond, the display shows “**AUTO N/A**”.
- Activation and completion of Auto Dockside are displayed as: “**AUTO WAIT**” and “**AUTO END**” respectively.
- The “**ALIGN RUD**” screen follows “**AUTO END**” if you have a rudder feedback transducer. The helm should be centred by hand and the rudder bar adjusted to zero using the **-1** and **+1** keys.

Quitting User Setup

To quit User Setup at any time, press **STANDBY** for 2 seconds.

* Not applicable to pre version 11 Type 100/300 Course Computer software

5.2 Dealer Setup: Type 100/300 Course Computer

This section describes the Dealer Setup options if you have installed the ST600R as the control unit for a Type 100/300 Course Computer. If you have installed the ST600R as a repeater unit on another autopilot system, please refer to the Dealer Setup instructions in the handbook for the main control unit.

Dealer Setup allows you to customise the autopilot to suit your boat. However, once you have set the Pilot Type, the factory default settings will provide safe performance for the initial sea trial, and fine tuning is not normally required.

The flow chart on below shows you how to enter Dealer Setup, scroll through the setup displays, adjust the values and exit.

ST600R Dealer ST600R Calibration Screens when used with the ST6000 Plus and Type 100/300 Course Computer

Dealer Calibration

Normal Operation

1 2

Dealer Calibration Menu

1 PLAN ING CAL	2 CAL LOCK OFF CAL	3 RUDD GAIN 2 CAL	4 RATE GAIN 6 CAL
5 ALIGN RUDD CAL	6 LIMIT RUDD 40 CAL	7 TURN RATE 20 CAL	8 SPEED CRS 10 CAL
9 OFF CRS 20 CAL	10 AUTO TRIM 2 CAL	11 POWER MODE 2 CAL	12 DRIVE TYPE 2 CAL
13 RUDD DAMP 1 CAL	14 VAR EAST 2 CAL	15 AUTO ADAP OFF CAL	16 LAT ADAP 2 CAL
17 AUTO REL OFF CAL	18 RESP 2 CAL	19 AUTO TACK 100 CAL ★	20 WIND TRIM 1 CAL

Adjusting Dealer Calibration Features

Quitting Dealer Calibration

SECONDS

* Not available on pre version 11 Type 100/300 Course Computers

ST600R Dealer Calibration Screens when used with the ST4000 Plus and ST5000 Plus Autopilots

The ST600R screen cycle for the ST4000 Plus and ST5000 Plus is as follows:

- Pilot Type (eg, 4000 WHL)
- Calibration Lock (CAL LOCK)
- Rudder Gain (RUDD GAIN)
- Response (RESP)
- Turn Rate (TURN RATE)
- Rudder Offset (ALIGN RUDD)
- Off Course (OFF CRS)
- Auto Tack (AUTOTACK)
- Cruise Speed (SPEED CRS)
- Rudder Damping (RUDD DAMP)
- Latitude (LAT ADAP)
- Variation (VAR EAST/WEST)
- Drive Type (DRIVE TYPE)
- Automatic Trim (AUTO TRIM)

Recommended Settings

The following pages list the default calibration settings for sailing/power displacement and planing power vessels. Once you have set the Pilot Type, these will provide good performance for initial sea trials and can be fine tuned later to optimise performance.

After initial calibration has been carried out, further adjustment can be made at any time.

The features that can be adjusted are listed in the table at the end of this chapter, where you can record your settings for future reference. Information on the functions of the different settings is given in the remainder of this section.

The following points should be noted:

- Make sure that the autopilot is in Standby mode before you access Dealer Setup
- Setup options are always saved on exit

Pilot Type (ST6000 Plus & Type 100/300)

This should be set when the system is first switched on. The default settings for other Dealer Setup options depend on the pilot type you select here.

Setting	Description
DISPL MNT	Displacement
SEMI DIS	Semi-displacement
PLANING	Planing
SOLENOID	Constant running solenoid system
STERN DRV	Sterndrive
Default:	PLANING

Pilot Type (ST4000 Plus and ST5000 Plus)

When the ST600R is used with the ST4000 Plus and ST5000 Plus autopilots, the following ‘pilot types’ may be selected.

Setting	Description
4000 WHL	ST4000 Plus Wheeldrive
4000 TILL	ST4000 Plus Tiller Pilot
5000 SAIL	ST5000 Plus SailPilot
5000 STRN	ST5000 Plus Sterndrive
5000 HYD	ST5000 Plus Hydraulic

Calibration Lock

Calibration lock controls whether User Setup and Intermediate Setup are available, and is intended for charter boat users.

Setting	Description
ON	Setup ON
OFF	Setup OFF
Default:	OFF

Rudder Gain

This must be set while under way, as described in Chapter 7, “Post Installation Procedures”.

Range:	1 to 9
Default:	5 (Displacement)
	5 (Semi-displacement)
	4 (Planing)
	3 (Sterndrive)

Rate Level

Rate Level monitors the speed at which rudder is applied when changing course. Rate level will, if the rate at which the vessel is turning is too fast, counter this turn with opposite rudder.

The settings available are as follows:

Range:	1 to 9
Defaults:	7 Displacement
	7 Semi-displacement
	7 Planing
	5 Sterndrive

Rudder Offset

You only need to set this option if your system includes a rudder reference unit.

- Manually place the helm in a central position. The reported rudder angle is indicated on the rudder bar graphic at the bottom of the screen.
- Adjust the offset value, using the **+1** and **-1** keys, until the rudder position is shown as central on the rudder bar. The offset must be within the range -7° to $+7^{\circ}$.

Range:	-7° to $+7^{\circ}$
Default:	0

Rudder Limit

Rudder Limit restricts autopilot rudder movement to just less than the steering systems mechanical stops. This avoids putting the steering system under unnecessary load.

The range available is as follows:

Range:	15° to 40°
Defaults:	30° Displacement, semi-displacement, planing 20° Sterndrive

Turn Limit

This limits the rate of turn of your vessel when under autopilot control. The value must be within the range 5 to 20°. For sailboat applications it should be set to 20°.

Range:	5° to 20° per second
Default:	20° (Displacement) 15° (Semi-displacement) 08° (Sterndrive)

Cruise Speed

The Cruise Speed value is used by the autopilot during Track mode operation, when it calculates compensation for tidal streams and leeway.

Set the value to the boat’s normal cruising speed.

Alternatively, set Cruise Speed to Auto mode (A) (not available when using a Type 100/300 Course Computer) so that Speed Over Ground (SOG) data is used, if available. SOG will normally give better course-keeping than a fixed value. However, using SOG could cause problems at low boat speeds where the tide exceeds 35% of the boat speed.

Note: If boat speed data is available via SeaTalk or NMEA, the Cruise Speed setting is ignored and the actual boat speed is used.

Range:	4 to 60 knots
Defaults:	6 (Displacement) 8 (Semi-displacement) 20 (Planing) 20 (Sterndrive)

Off Course Alarm

This is the off course alarm angle. It controls the alarm that warns you if the autopilot is unable to maintain its set course.

The alarm operates if the autopilot strays off course by more than the alarm angle limit for more than 20 seconds.

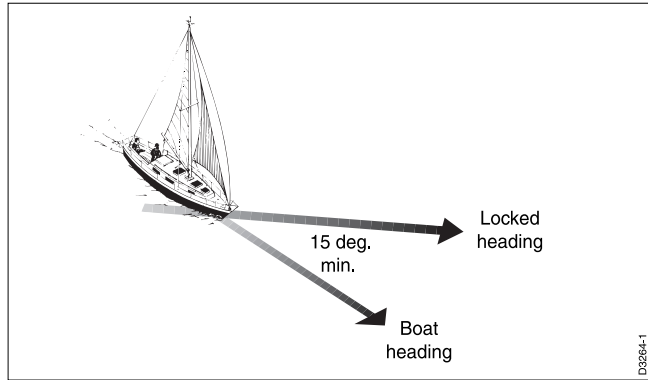

The value must be within the range 15 to 40°, and can be adjusted in 1° steps.

Range: 15 to 40°

Default: 20°

AutoTrim

The AutoTrim level setting determines the rate at which the autopilot applies “standing helm” to correct for trim changes caused by varying wind loads on the sails or superstructure. The settings are:

Setting	Effect	Recommended for:
1	Slow trim correction	Heavy displacement vessels, with full keel or transom rudder.
2	Medium trim correction	Heavy displacement vessels.
3	Fast trim correction	Moderate to light displacement vessels.
4	Super fast correction	Planing power vessels
Default:		3

The default setting (Level 3) should provide optimum performance with the ST600R autopilot. However, depending on the vessel’s dynamic stability, an incorrect rate of trim application may result in poor course keeping due to autopilot instability.

After gaining experience with the ST600R, you may wish to change the setting. The effect of the setting must be evaluated while under sail.

- Decrease the AutoTrim level if the autopilot gives unstable course keeping or excessive drive activity with a change in the heel angle.
- Increase the AutoTrim level if the autopilot reacts slowly to a heading change due to a change in the heel angle.
- For systems without a rudder reference unit, these settings have no effect and trim is set to level 3.

Power Steer

Power steer selects the Joystick mode of operation: Proportional or ‘Bang-Bang’.

Proportional applies rudder in proportion to Joystick movement – the further the Joystick is held over the greater the applied rudder.

Bang-Bang applies continuous rudder drive in the direction of lever movement. To improve control the speed of rudder movement changes with the angle of the lever. For maximum speed push the lever hardover. If the lever is returned to the centre position the rudder will remain in its current position.

The settings available are as follows:

Range:	1 = Proportional 2 = Bang-bang
Default:	1

Drive Type

The drive type controls the way which the autopilot drives the steering system. The default setting should be retained for mechanically driven vessels.

Range:	1 = Mechanically driven vessels without a rudder reference unit 2 = Hydraulic, no rudder reference unit 3 = Linear, rotary and sterndrive with a rudder reference unit 4 = Hydraulic with rudder reference unit
Default:	1

Rudder Damping

You only need to set this option if your system includes a rudder reference unit, and the drive “hunts” when trying to position the rudder. Test for this when your vessel is moored dockside, by pressing **AUTO** and then **+10**. If the helm overshoots and has to drive back or starts to hunt back and forth, you need to increase the damping level.

In auto mode (A), the autopilot applies damping compensation automatically – **not available if using a Type 100/300 Course Computer**.

Alternatively, you can set a value in the range 1 to 9. Adjust the damping one level at a time, and always use the lowest acceptable value.

Range:	1 to 9
--------	--------

Default:	1
-----------------	---

Variation

If required, set this value to the level of magnetic variation present at your vessel’s current position. +ve variation = East, -ve variation = West. The variation setting is sent to other instruments on the SeaTalk system, and can be updated by other SeaTalk instruments.

Range:	-30° to +30°
--------	--------------

Default:	Off
-----------------	-----

AutoAdapt

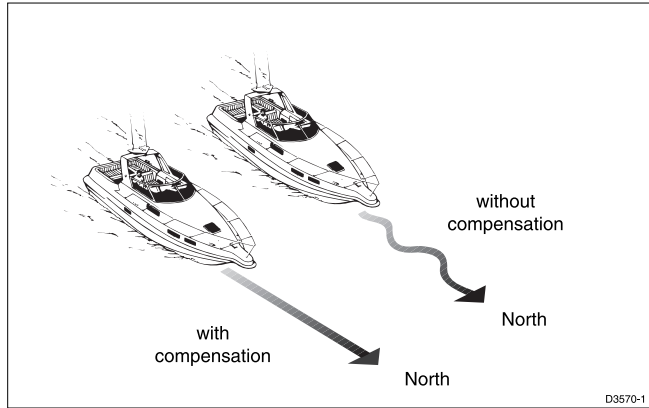

The patented AutoAdapt feature allows the autopilot to compensate for heading errors at higher latitudes, which are caused by the increasing dip of the earth’s magnetic field. The increased dip has the effect of amplifying rudder response on northerly headings in the northern hemisphere, and on southerly headings in the southern hemisphere.

Set AutoAdapt to “nth” in the northern hemisphere, or “sth” in the southern hemisphere. You then need to enter your current latitude in the next setup screen, so that the autopilot can provide accurate course keeping by automatically adjusting the rudder gain depending on the heading.

Range:	Off = Off nth = North sth = South
Default:	Off

Latitude

This screen is only used if AutoAdapt is set to North or South.

Use the **+1**, **-1**, **+10**, and **-10** keys to set the value to your vessel’s current latitude, to the nearest degree.

Range:	0 to 80°
Default:	Off

Note: If valid latitude data is available via SeaTalk, it will be used instead of this calibration value.

Auto Tack*

The AutoTack angle is the angle through which the vessel will turn when the automatic tack feature is selected. The value must be within the range 40 ~ 125° and can be adjusted in 1° steps.

Wind Trim*

This varies the response of the autopilot when in wind mode.

The settings available are as follows:

Range:	1 Normal setting
	2 Faster response for wind shifts
Default:	1

Auto Release

Auto Release provides emergency manual override, should it be necessary, to avoid an obstacle at the last moment. This option only applies to sterndrive actuators – for all other systems this option should be set to off.

Range:	Off
	On
Defaults:	0 for Displacement, Semi-displacement & Planing
	1 for Sterndrives

Response

This is the power-on response setting. The response level can be changed during normal operation (see Section 3.3) or via the Response Data Page, if this is set for display (see Section 2.6).

Range:	Level 1 (Auto Seastate)
	Level 2 (Auto sea state inhibit)
	Level 3 (Auto sea state inhibit counter rudder)
Default:	Level 1

*Not available on th ST4000 Plus and ST5000 Plus

Recording Calibration Settings

Having fine-tuned the calibration settings during initial sea trials, record them in the following table for future reference.

Feature	Setting
Pilot Type	
Calibration Lock	
Rudder gain	
Response	
Turn rate Limit	
Rudder Offset	
Off Course Alarm	
AutoTrim	
Drive Type	
Variation	
AutoAdapt	
Latitude	
Rudder Damping	
AutoRelease	
Cruise Speed	
Power Speed	
Rudder Limit	
Rate Level	

Chapter 6: Installation

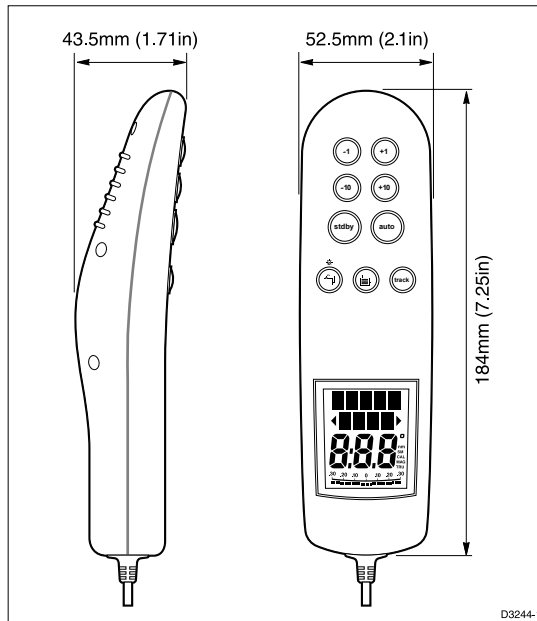

The ST600R remote unit is connected directly to Raymarine autopilots or instruments using the Raymarine data interface system (SeaTalk bus).

The ST600R is supplied with a waterproof plug and socket (deck connector) that can be installed anywhere a remote is required. The deck connector allows you to make connections directly to the autopilot, or any SeaTalk instrumentation, and can be connected in-line or as a spur (see below).

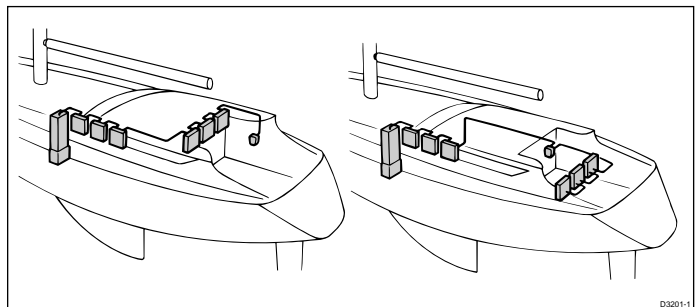

This chapter describes the following:

- Planning the installation, including choosing the connection cable
- Determining the connections for your autopilot
- Mounting the bulkhead socket
- Installing the bulkhead bracket

6.1 Planning the Installation

This chapter explains how to install the ST600R autopilot control unit. Before you start, obtain the correct connection cable, and decide how you will site the unit and run the cables.

Choosing the Correct Connection Cable

Because the range of Raymarine autopilots is extensive, the cable used to connect the ST600R must be ordered separately (see below).

Part Number	Cable Description
D131	Round connectors at both ends, 9m (29ft. 3in.)
D177	No plugs but fitted with an in-line 5A fuse, 3m (9ft. 9in.)
D229	Flat moulded plug with bare ends, 3m (9ft. 9in.)
D284	Flat moulded plugs at both ends, 1m (3ft. 3in.)
D285	Flat moulded plugs at both ends, 3m (9ft. 9in.)
D286	Flat moulded plugs at both ends, 6m (19ft. 6in.)
D287	Flat moulded plugs at both ends, 9m (29ft. 3in.)
Q018	SeaTalk cable (no plugs) sold by the 0.3m (1ft)

Cabling Guidelines

- Avoid running cables through bilges where possible
- Secure coiled lengths at regular intervals
- Avoid running cables close to fluorescent lights, engines, radio transmitting equipment etc

EMC Installation Guidelines

The design and manufacture of Raymarine equipment and accessories conforms to the appropriate Electromagnetic Compatibility (EMC) standards, but good installation is required to ensure that performance is not compromised.

To avoid the risk of operating problems, all Raymarine equipment and cables connected to it should be;

- At least 1m (3 feet) from any equipment transmitting or cables carrying radio signals e.g. VHF radios, cables and antennas. In the case of SSB radios, the distance should be increased to 2m (7ft).
- More than 2m (6ft) from the path of a radar beam. A radar beam can normally be assumed to spread 20 degrees above and below the radiating element.
- The equipment should be supplied from a different battery than the one used for engine start. Voltage drops below 10v in the power supply to our products can cause the equipment to reset. This will not damage the equipment, but will cause the loss of some information and can change the operating mode.
- Genuine Raymarine cables should be used at all times. Cutting and rejoining these cables can compromise EMC performance and so should be avoided unless doing so is detailed in the installation manual.
- If a suppression ferrite is attached to a cable, this ferrite should not be removed. If the ferrite has to be removed during installation it must be reassembled in the same position.

If your Raymarine equipment will be connected to other equipment using a cable not supplied by Raymarine, a suppression ferrite **MUST** always be fitted to the cable close to the Raymarine unit.

The following illustration shows the range of suppression ferrites fitted to Raymarine equipment.

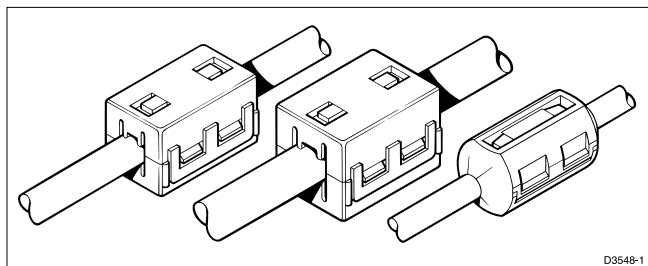

6.2 Connections

The cable connections depend on the autopilot to which you are connecting the remote unit. The following sections show the connections required for:

- ST1000 and ST2000 Plus autopilots
- ST4000 Plus and ST5000 Plus autopilots
- ST6000 Plus control unit
- Type 100/300 Course Computer

If you have purchased SeaTalk cable fitted with connectors at both ends, one of these connectors will have to be removed, and the bare end stripped back to reveal the red, yellow and screen wires.

ST1000 and ST2000 Plus Autopilot Connections

The ST600R can also be connected to any available SeaTalk instrument as well as the autopilot. For details of the pin connections, please refer to the appropriate autopilot handbook.

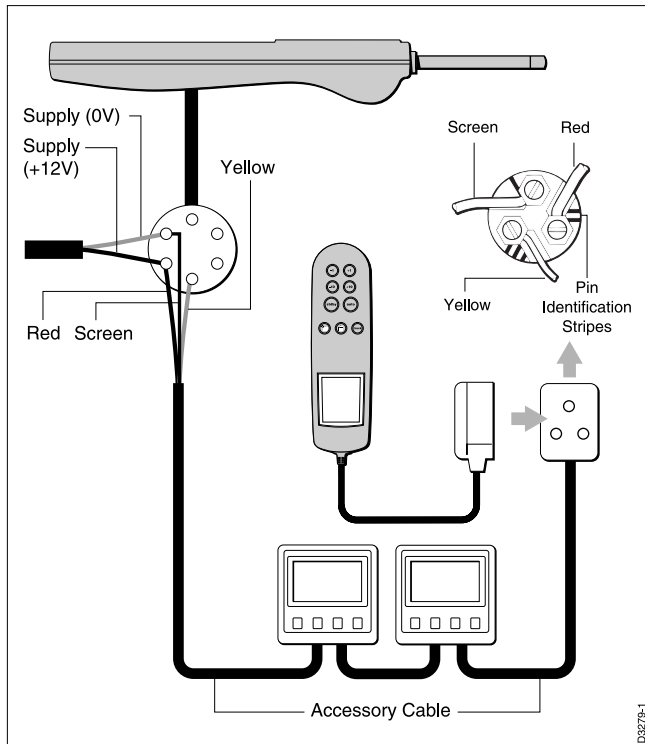

ST4000/5000/6000 Plus Connections

The ST4000/ST5000/ST6000 Plus control units have two parallel SeaTalk connection ports – either one can be used.

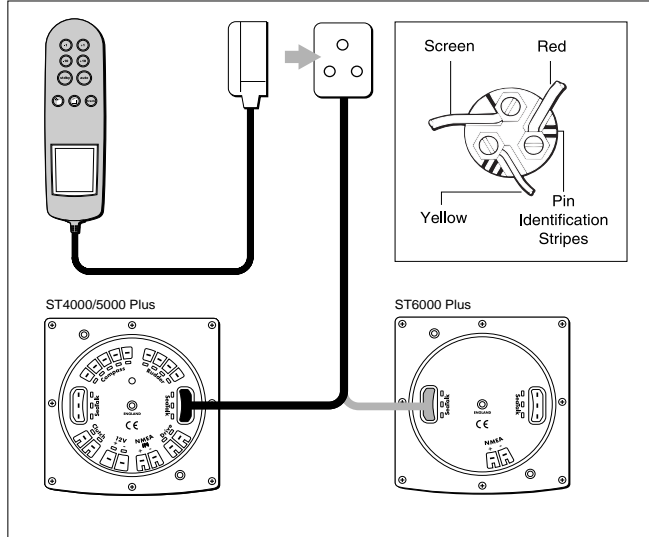

The ST600R can also be connected to any available SeaTalk instrument as well as the autopilot.

ST6000 & ST7000 Autopilot Connections

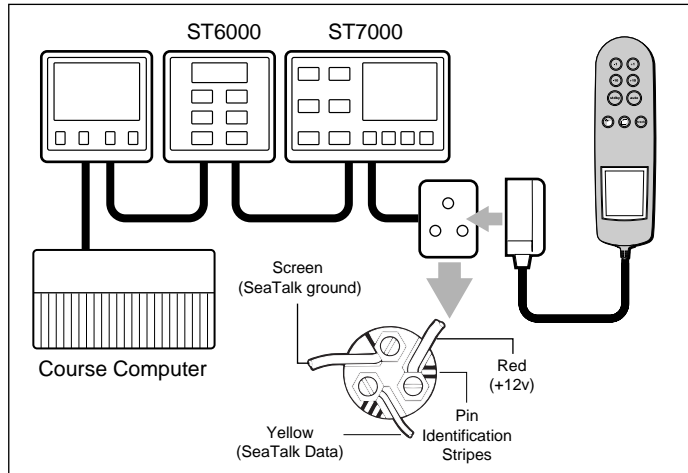

Note: The hand held socket can be installed anywhere on the SeaTalk bus.

6.3 Mounting the Bulkhead Socket

1. Apply the template to the bulkhead as required.
2. Drill the 18mm (45/64in) clearance hole and the two 2.4mm (3/32in) pilot holes.
3. Remove the template.
4. Fit the plug cap (1) to the socket body (2) as shown.
5. Cut and strip the SeaTalk cable (not supplied - refer to table).
6. Pass the cables through the bulkhead and wire to the socket, making sure the wires are connected to the correct pins.

7. Use the two self-tapping screws to attach the socket to the bulkhead.

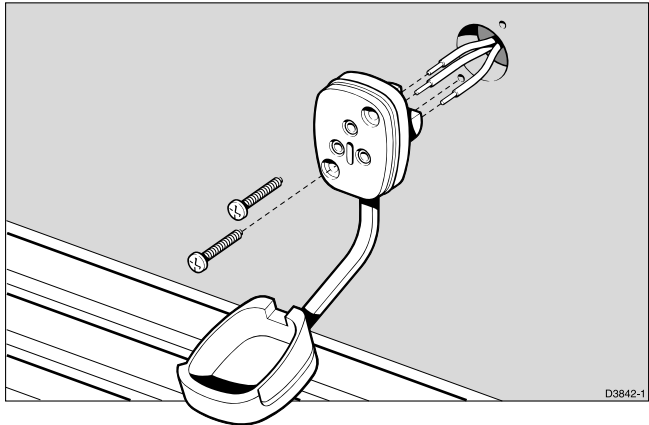

9. Secure the cables at regular intervals using suitable cable ties.

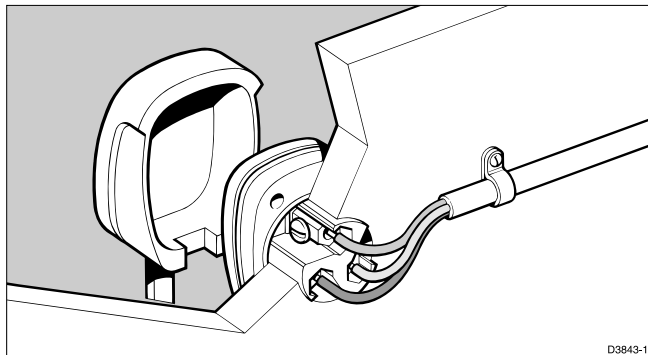

6.4 Bulkhead Bracket Installation

The hand held remote is supplied with a stowage bracket. This bracket should be attached to a convenient bulkhead using the screws provided.

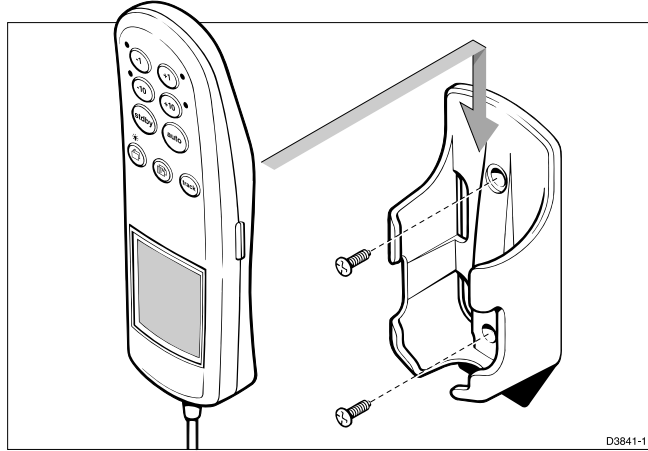

6.5 Functional Test (Repeater Unit)

If you have installed your ST600R as an autopilot repeater, you should perform the functional test described in this section. However, if you have installed the ST600R as the only control unit for a Type 100/300 course computer, go to **Chapter 7, “Post Installation Procedures”**, and follow the instructions.

Switch On

Having installed your ST600R, switch on the main power breaker. If the control head is active and the system operating, the following will occur:

- The control head beeps and displays the pilot type, ST600R.
- After 2 seconds, the Standby mode screen should be displayed.

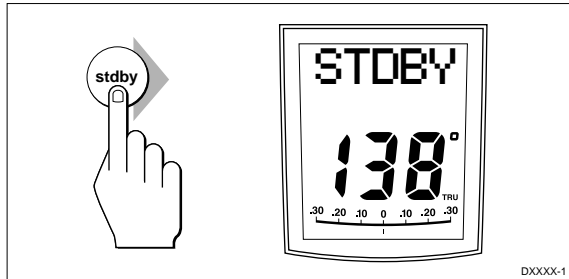

This shows that the control head is active. If the unit does not beep, check the fuse/circuit breaker.

If “NO LINK” is displayed, check the link between the ST600R control head and the Course Computer.

SeaTalk Interface

If the ST600R is linked to other SeaTalk instruments via SeaTalk, the link can be checked as follows:

1. Press **STANDBY**.
2. Select display illumination level 3 on any other SeaTalk instrument or autopilot control unit.

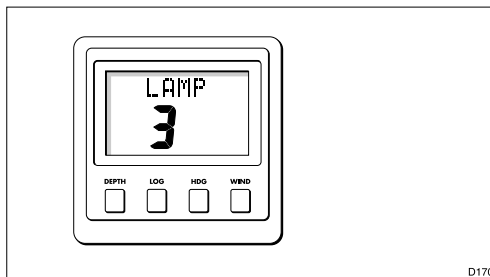

The ST600R should immediately respond by switching on its display illumination.

If the illumination does not switch on, a cabling fault exists in the SeaTalk cabling between the ST600R control head and the instruments/control unit.

Chapter 7: Post Installation Procedures

This chapter applies to systems where the ST600R has been installed as the only control unit for a Type 100/300 Course Computer.

Once you have installed the system, you need to confirm that it is wired correctly and is also set up to suit your type of boat.

This chapter provides instructions for the following procedures:

- **Functional test**, consisting of a few simple tests to confirm that the system is wired correctly
- **Initial sea trial**, to swing the compass and align the heading, check the autopilot's operation and check the rudder gain

Further customisation can be performed after the sea trial, as described in Chapter 5.

7.1 Functional Test and Initial Calibration

Switch On

Once you have installed your ST600R system, switch on the main power breaker. If the control head is active and the system operating, the following will occur:

- The control head beeps and displays the pilot type as ST600R.

This shows that the control head is active.

- If the head does not beep, check the fuse/circuit breaker.
- If the SEATALK FAIL alarm is displayed, check the SeaTalk connections.

Operating Sense

The operating sense defines the direction the helm will be applied when a course change key is pressed or the vessel goes off course. Check the operating sense as follows:

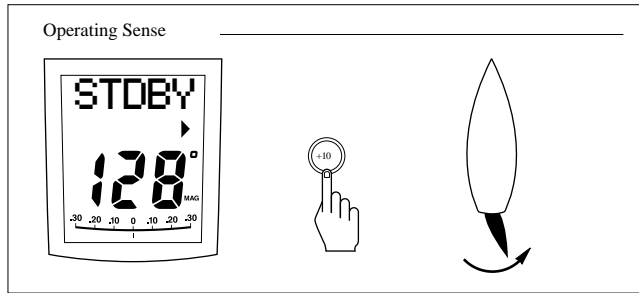

1. Press **AUTO**.
2. Press the **+10** key. The helm should move to produce a turn to starboard.



3. If the helm produces a turn to port, reverse the motor connections at the course computer.
4. If the helm overshoots and has to drive back or starts to hunt back and forth, you need to increase the Rudder Damping option in Dealer Setup (see Chapter 5).

Navigation Interface (GPS, Decca, Loran)

If the course computer is interfaced to a navigator, via an NMEA data port, the interface can be checked by displaying the Data Pages.

Press  to display the first chapter heading. After 2 seconds, the first data page in this chapter is displayed. Press  to check each successive page.

If dashes are displayed instead of data values, the cause could be one or more of the following:

- A cabling error. Check for an open circuit, short circuit or reversed wires.
- The navigator is not configured to transmit the required data format.
- The signals being received by the navigator are too weak for reliable navigation. Refer to the navigator handbook for further action.

Wind Transducer Interface

If the course computer is connected to a wind instrument via an NMEA port or SeaTalk, then the link between the two instruments should be checked as follows:

Press **STANDBY** and **AUTO** together.

The ST600R should display the Vane mode screen, with the locked wind angle and locked heading as shown.

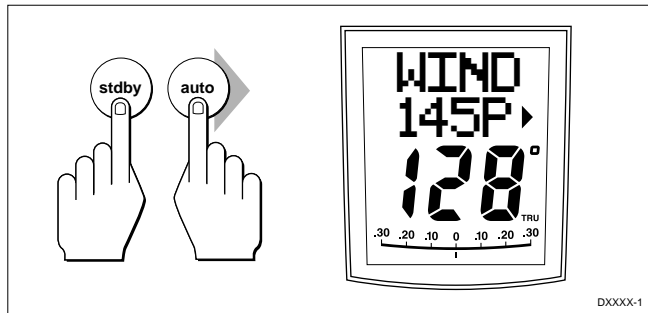

Alternatively, if the wind data is not received, the ST600R will display a NO DATA error message.

EMC Conformance

The design and manufacture of Raymarine equipment and accessories conforms to the appropriate Electromagnetic Compatibility (EMC) standards, but good installation is required to ensure that performance is not compromised. Although every effort has been taken to ensure that they will perform under all conditions, it is important to understand what factors could affect the operation of the product.

Always check the installation before going to sea to make sure that it is not affected by radio transmissions, engine starting etc..

In some installations, it may not be possible to prevent the equipment from being affected by external influences. In general this will not damage the equipment but can lead to it resetting, or momentarily may result in faulty operation.

7.2 Initial Sea Trial

Having checked that the system is functioning correctly, a short sea trial is now required to complete the setup. It involves the following procedures:

- Automatic compass deviation correction
- Heading alignment adjustment
- Autopilot operation check
- Rudder gain adjustment

The initial sea trial should be performed in the following circumstances:

- After all the installation, functional test and initial calibration have been completed successfully
- Before any other changes have been made to the default calibration settings: check and, if necessary, reset the values to the recommended levels, as described in Chapter 5
- In conditions of light wind and calm water, so that autopilot performance can be assessed without the influence of strong winds or large waves
- In waters clear of any obstructions

Note: At any time during the sea trial you can press **STANDBY** to return to hand steering.

Automatic Compass Deviation Correction

The autopilot will correct the fluxgate compass for most deviating magnetic fields. Compass errors due to deviating magnetic fields can be as great as 15° or even 45° , depending on your vessel type. The correction procedure reduces these to a few degrees, so it is essential to perform the procedure as the first item in your initial sea trial.

Caution: Failure to carry out the deviation correction may result in impaired autopilot performance on some compass headings.

To allow the system to determine the deviation and calculate any correction required, you must turn your vessel in slow circles. This procedure must be carried out in calm conditions and preferably in flat water.

To perform the deviation correction:

1. Make sure that the autopilot is in Standby mode with the drive unit engaged.
2. Press and hold the **STANDBY** key for 2 seconds to display the User Setup entry page.

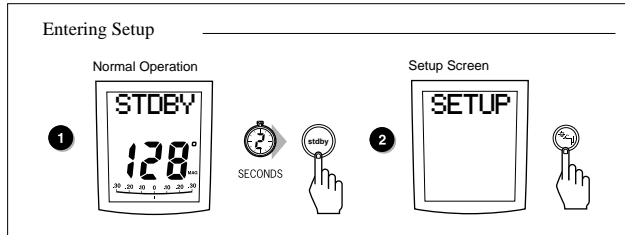

If “CAL LOCK” is displayed, you need to turn off the lock feature contained in Dealer Setup (see Chapter 5).

3. Press the  key to move on to the Swing Compass page.

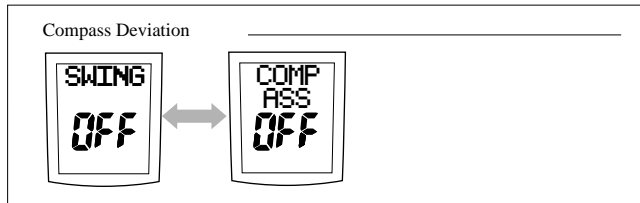

4. Press the **+1** or **-1** key to change the setting from OFF to YES. The Turn Boat page is then displayed after 1 second.

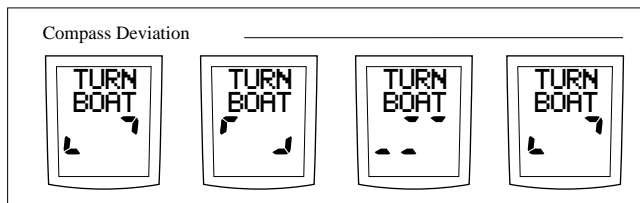

- 5. Keeping the boat speed below 2 knots, turn the vessel in slow circles. It should take at least 3 minutes to complete 360°.

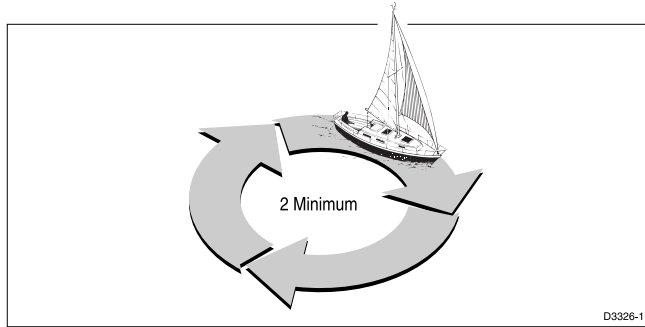

- 6. Keep turning your boat until the unit beeps and the Deviation screen is displayed.

This shows the maximum deviation detected, and indicates that compass correction has been completed successfully.

Note: If the deviation value exceeds 15°, you should consider moving the fluxgate compass to a better location.

- 7. Press the  key to move on to the Heading Alignment page.
- 8. Use the **+1** and **-1** keys, or the **+10** and **-10** keys, to increase or decrease the displayed heading, until it agrees with the ship's steering compass or a known transit bearing.

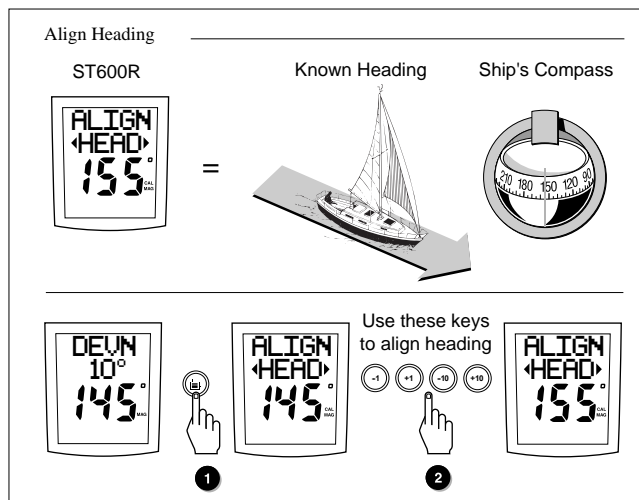

9. Press and hold **STANDBY** for 2 seconds to exit calibration and save the new settings.

Note: Setup options are always saved on exit.

Further Heading Alignment Adjustment

You should always check the compass alignment after swinging the compass. However, once the initial deviation correction procedure has been performed, you can make adjustments to the alignment as often as you wish, without swinging the compass again.

Although the compass deviation correction procedure removes most of the alignment error, you will probably be left with small errors (of the order of a few degrees) that will vary depending on the heading.

Ideally, you should check the heading reading against a number of known headings, plot a deviation curve, and determine the heading alignment value that will give the lowest **average** alignment error. This value can then be entered on the Heading Alignment screen, as described above.

If the average heading error is more than 5° , you should perform the compass deviation correction procedure again.

Checking Autopilot Operation

Having calibrated the compass the following procedure is recommended to familiarise yourself with autopilot operation:

1. Steer onto a compass heading and hold the course steady.
2. Press **AUTO** to lock onto the current heading. A constant heading should be achieved in calm sea conditions.
3. Use the **-1**, **-10**, **+1** and **+10** keys to alter course to port or starboard in multiples of 1° and 10°
4. Press **STANDBY** and disengage the autopilot to return to hand steering.

Checking the Rudder Gain

The factory setting for rudder gain will provide stable control for initial sea trials. However, vessels can vary widely in their response to the helm, and further adjustment to the rudder gain may improve the autopilot's steering characteristics.

It is important to ensure that rudder gain is set correctly on high-speed craft. Incorrect adjustment will lead to poor steering performance and is dangerous at high speeds.

The following test will determine whether the rudder gain is set too high or too low.

1. In clear water and with the autopilot in Auto, alter course to starboard by 40° by pressing the **+ 10** key four times.
 - At cruising speeds, course changes of 40° should result in crisp turns followed by an overshoot of no more than 5°. If this occurs the rudder gain is adjusted correctly.
 - An excessively high rudder setting results in oversteer. This is recognised by a distinct overshoot of more than 5° (A). This condition can be corrected by reducing the rudder gain setting.
 - Similarly, an insufficient rudder control setting will result in understeer which gives sluggish steering performance (B). If the vessel takes a long time to make the turn and there is no overshoot then the rudder setting is too low.

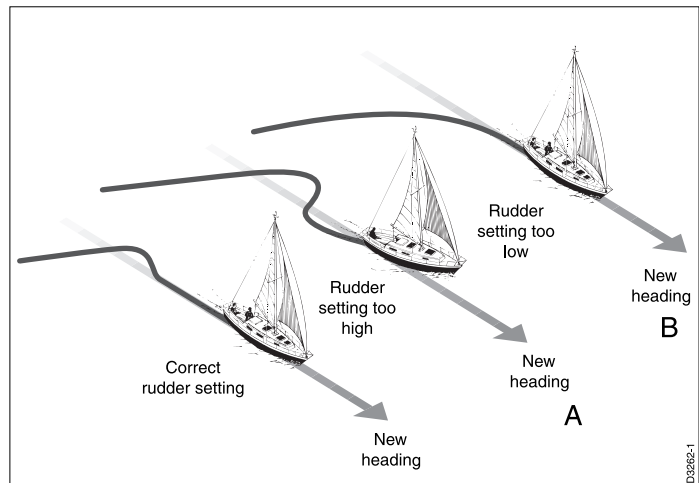

These actions are most easily recognised in calm sea conditions where wave action does not mask basic steering performance.

2. Refer to Chapter 5, “Customising the System”, for instructions on how to adjust the default rudder gain setting. Note that you can also make temporary adjustments to rudder gain during normal operation (see Section 3.3).
3. Repeat the test until a crisp course change with no more 5° of overshoot is achieved.

The rudder control setting should be set to the lowest setting consistent with accurate course keeping. This will minimise helm movements and hence reduce power consumption and wear and tear.

Chapter 8: Maintenance

General

- In certain conditions, condensation may appear on the LCD window. This will not harm the unit, and can be cleared by switching on the illumination for a while.
- **Never** use chemical or abrasive materials to clean your autopilot. If the pilot is dirty, wipe it with a clean, damp cloth.
- Periodically check the cabling for chafing or damage to the outer casing – replace any damaged cables.

Servicing and Safety

- Raymarine equipment should be serviced only by authorised Raymarine service engineers. They will ensure that service procedures and replacement parts used will not affect performance. There are no user serviceable parts in any Raymarine product.
- Some products generate high voltages, and so never handle the cables/connectors when power is being supplied to the equipment.
- Always report any problem related to Electromagnetic Compatibility (EMC) to your nearest Raymarine dealer. We will use any such information to improve our quality standards.

Advice

Should any difficulties arise with this product, please contact the Raymarine Product Support department in the UK, or your own national distributor who will be able to provide expert assistance.

Before you consider returning the remote, make sure that the power supply cable is sound and that all connections are tight and free from corrosion.

If the connections are secure, refer to the Fault Finding chapter of this handbook. If the fault cannot be traced or rectified, please contact your nearest Raymarine dealer or Service Centre.

Always quote the product serial number, which is printed on the rear cover, and the software version number, which is displayed when you enter Intermediate Setup (see Chapter 5).

Chapter 9: Fault Finding

All Raymarine products are subjected to a comprehensive test procedure prior to packing and shipping. In the unlikely event that a fault does occur with your autopilot, the following check list should help identify the problem and provide a cure.

The display is blank

- No power – check the fuse/circuit breaker.

The display shows “CODE ----” at power on

- The CodeLock code must be entered manually (see Chapter 4).

The displayed compass heading does not agree with the ships compass

- The compass has not been corrected for deviation – carry out the deviation and alignment procedures.

Vessel turns slowly and takes a long time to come on to course

- Rudder gain too low.

Vessel overshoots when turning on to a new course

- Rudder gain too high.

The autopilot appears to be unstable in Track mode, or track-holding is slow

- If tide speed exceeds 35% of boat speed, and boat speed is not available via SeaTalk, change the Cruise Speed setting in Dealer Setup from Auto (A) to the boat’s cruising speed.

The autopilot appears to be unstable on Northerly headings in the Northern hemisphere and Southerly headings in the Southern hemisphere

- Northerly/Southerly heading correction not set up.

Display shows CAL LOCK when entering calibration

- Calibration locked out – calibration protection feature is turned on in Dealer Setup.

The autopilot will not “talk” to other SeaTalk instruments

- Cabling problem – make sure all the cables are connected properly.

Position information not received

- Navigator not transmitting the correct position data.

The autopilot will not auto advance to the next waypoint

- No bearing to waypoint information received from the navigator.

A series of rotating dashes are displayed on screen

- Compass deviation correction or dockside rudder calibration is running.

The display shows a series of stationary dashes

- Data is not being received – check the cabling.

The display shows “NO DATA”

- The signals received from the navigator are too weak – refer to the navigator handbook for further action.

Locked wind angle cannot be engaged or adjusted

- This feature is not available if you have a Type 100/300 Course Computer running software prior to version 11.

Index

A

- Adjusting the Locked Wind Angle 21
- Advance 19
- Advanced Operation 14
- Advice 71
- Alarms 26
- Apparent Wind Angle 22
- Apparent wind angle
 - Adjusting 21
 - Previous 22
- Auto Mode 5
- Auto mode 5–10
- Auto Release 27, 49
- Auto Tack 49
- AutoAdapt 48
- Automatic Acquisition 15
- Automatic Compass Deviation Correction 64
- Automatic Deadband 25
- Automatic Tack 8
- Automatic track acquisition 15
- Autopilot Operation 67
- Autopilot Performance 25
- AutoRelease 49
- AutoSeastate 25
- AutoTack 8
 - Vane mode 23
- AutoTack in Vane Mode 23
- AutoTack to Port 8
- AutoTack to Starboard 8
- AutoTrim 45

B

- Bar graph 4
- Bar Selection 38
- Basic Operation 3
- Bulkhead Bracket Installation 58
- Bulkhead Socket 56
- Bulkhead socket 56

C

- Cable 52
- Cabling 52, 71
- Cabling Guidelines 52
- Calibration Lock 42
- Cancelling a Dodge Manoeuvre 19
- changed, or if the operating mode is changed.Wind 27
- Changing Course 6
- Changing course 6
- Changing Course in Auto Mode 6
- Changing the Code or Master Unit 33
- Changing the Response Level 25
- Changing the Rudder Gain 26
- Checking Autopilot Operation 67
- Checking the Rudder Gain 68
- Code number 33
- Code Number Problems 34
- CodeLock 31, 31–34
- CodeLock Modes 31
- Compass alignment 66
- Compass Deviation Correction 37, 64
- Compass deviation correction 37, 64
- Connections 54
- Course changes 6
 - operating hints 9
- Course Changes Under Autopilot Control 9
- Cross Track Error 17
- Cross track error (XTE) 17
- Cruise Speed 44
- Cruise speed 49
- Customising the autopilot 35–50
- Customising the System 35

D

- Data Not Received 28
- Data Pages 12
- Deadband 25
- Dealer Setup 39, 39–50
- Deviation 66
- Deviation Display 37
- Disengaging the Autopilot 5
- Disengaging the autopilot 5
- Display and Keypad Illumination 11
- Display Layout 4
- Display layout 4

- Dodges 19, 22
- Dodging Obstacles 6
- Dodging obstacles
 - Auto mode 6
 - Track mode 19
 - Vane mode 22
- Dodging Obstacles in Auto Mode 6
- Drive Stopped 28
- Drive Stopped alarm 28
- Drive Type 46
- Drive type 46

E

- EMC Conformance 63
- EMC Installation Guidelines 53
- Engaging the autopilot 5
- Entering Your Code 33

F

- Fault Finding 72
- Fault finding 72
- Functional Test 58
- Functional test
 - course computer installations 61–63
- Functional test (repeater unit) 58
- Functional Test and Initial Calibration 61
- Further Heading Alignment Adjustment 67

G

- Graph use 38
- Gusty Conditions 10

H

- Hand steering 5
- Heading 7
- Heading Alignment 37
- Heading alignment 37
- Heading Alignment Adjustment 67
- Heading alignment adjustment 67
- Heading Mode 37
- Heading mode 37

I

- Illumination 11
- Initial Sea Trial 64
- Initiating a Dodge Manoeuvre 19
- Initiating Track Mode 14
- Installation 51, 51–60
- Interfaces 62
- Intermediate Setup 31

K

- Key Functions 3
- Key functions 3
- Keypad Illumination 11

L

- Large Cross Track Error 27
- Large Cross Track Error alarm 17
- LAST HDG 7
- LAST WND 22
- Latitude 48
- Lighting 11
- Locked Wind Angle 21
- Low Battery 29
- Low Battery alarm 29

M

- Maintenance 71
- Major Course Changes 9
- Making Major Course Changes 9
- Man Overboard 29
- Man Overboard (MOB) 29
- Manual Acquisition 16
- Manual Mode 10
- Manual mode 10
- Manual steering 5
- Manual track acquisition 16
- Master unit (CodeLock) 31
- Minimum Deadband 25
- Mounting the bulkhead socket 56

N

- Navigation data displays 12
- Navigation Interface 62
- Navigation interface (GPS, Decca, Loran) 62
- No Link 27

O

- Off Course 27
- Off Course Alarm 9, 45, 46
- Off Course alarm 9
 - Default angle 46
- Operating Hints 9, 24
- Operating modes 1
- Operating Sense 62
- Operating sense 62
- Operation in Vane Mode 20
- Overview 1

P

- Performance 25
- Pilot Type 37, 42
- Pilot type 42
- Planning the Installation 52
- Plot Frequency 20
- Position Confirmation at the Start of a Passage 19
- Post Installation Procedures 61
- Power Steer 46
- Previous Apparent Wind Angle 22
- Previous heading 7
- Previous Locked Heading 7

R

- Rate Level 43
- Recommended Settings 41
- Recording Calibration Settings 49
- Response 43, 49
- Response Level 25
- Response level 25
 - Default setting 43
- Returning to the Previous Apparent Wind Angle 22
- Returning to the Previous Locked Heading 7
- Rudder bar 38
- Rudder Calibration 38
- Rudder Damping 47
- Rudder Gain 26, 43, 68
- Rudder gain 26, 43, 68
- Rudder Limit 44, 49
- Rudder Offset 43, 46
- Rudder offset 46

S

- Safety 19
- Sea trial 64
- SeaTalk data displays 12
- SeaTalk Data Pages 12
- SeaTalk Failure 27
- SeaTalk Interface 59
- SeaTalk interface 59
- Selecting Vane Mode 21
- Servicing 71
- Servicing and Safety 71
- Setting Up CodeLock 31
- Setting Waypoints 20
- Skipping a Waypoint 19
- Specification 2
- ST1000 and ST2000 Plus Autopilot Connections 54
- ST4000/5000/6000 Plus Connections 55
- ST6000 & ST7000 Autopilot Connections 56
- Standby mode 5
- Steering bar 38
- Swinging the compass 64
- Switch On 59, 61

T

- Testing autopilot operation 67
- Testing the system 58–60, 61–63
- Tidal Stream Compensation 18
- Tidal stream compensation 18
- Track acquisition 14
- Track Mode 14
- Track mode 14–20
- Turn Limit 44
- Turn limit 44

U

- User Setup 35

V

- Vane Mode 20, 21
- Vane mode 20–24
- Variation 47
- Verifying Computed Positions 20
- Version number 33

W

- Watch Alarm 29
- Watch alarm 29
- Waypoint Advance 28
- Waypoint Arrival and Advance 18
- Waypoint arrival and advance 18
- Wind Shift 27
- Wind Shift Alarm 23
- Wind Shift alarm 23
- Wind Transducer Interface 63
- Wind transducer interface 63
- Wind Trim 49
- WindTrim 20, 20–24

Limited Warranty Certificate

Raymarine warrants each new Light Marine/Dealer Distributor Product to be of good materials and workmanship, and will repair or exchange any parts proven to be defective in material and workmanship under normal use for a period of 2 years/24 months from date of sale to end user, except as provided below.

Defects will be corrected by Raymarine or an authorized Raymarine dealer. Raymarine will, except as provided below, accept labor cost for a period of 2 years/24 months from the date of sale to end user. During this period, except for certain products, travel costs (auto mileage and tolls) up to 100 round trip highway miles (160 kilometres) and travel time of 2 hours, will be assumed by Raymarine only on products where proof of installation or commission by authorized service agents, can be shown.

Warranty Limitations

Raymarine Warranty policy does not apply to equipment which has been subjected to accident, abuse or misuse, shipping damage, alterations, corrosion, incorrect and/or non-authorized service, or equipment on which the serial number has been altered, mutilated or removed.

Except where Raymarine or its authorized dealer has performed the installation, it assumes no responsibility for damage incurred during installation.

This Warranty does not cover routine system checkouts or alignment/calibration, unless required by replacement of part(s) in the area being aligned.

A suitable proof of purchase, showing date, place, and serial number must be made available to Raymarine or authorized service agent at the time of request for Warranty service.

Consumable items, (such as: Chart paper, lamps, fuses, batteries, styli, stylus/drive belts, radar mixer crystals/diodes, snap-in impeller carriers, impellers, impeller bearings, and impeller shaft) are specifically excluded from this Warranty.

Magnetrons, Cathode Ray Tubes (CRT), TFT Liquid Crystal Displays (LCD) and cold cathode fluorescent lamps (CCFL), hailer horns and transducers are warranted for 1 year/12 months from date of sale. These items must be returned to a Raymarine facility.

All costs associated with transducer replacement, other than the cost of the transducer itself, are specifically excluded from this Warranty.

Overtime premium labor portion of services outside of normal working hours is not covered by this Warranty.

Travel cost allowance on certain products with a suggested retail price below \$2500.00 is not authorized. When/or if repairs are necessary, these products must be forwarded to a Raymarine facility or an authorized dealer at owner's expense will be returned via surface carrier at no cost to the owner.

Travel costs other than auto mileage, tolls and two (2) hours travel time, are specifically excluded on all products. Travel costs which are excluded from the coverage of this Warranty include but are not limited to: taxi, launch fees, aircraft rental, subsistence, customs, shipping and communication charges etc. Travel costs, mileage and time, in excess to that allowed must have prior approval in writing.

TO THE EXTENT CONSISTENT WITH STATE AND FEDERAL LAW:

(1) THIS WARRANTY IS STRICTLY LIMITED TO THE TERMS INDICATED HEREIN, AND NO OTHER WARRANTIES OR REMEDIES SHALL BE BINDING ON RAYMARINE INCLUDING WITHOUT LIMITATION ANY WARRANTIES OF MERCHANTABILITY OR FITNESS FOR A PARTICULAR PURPOSE.

(2) Raymarine shall not be liable for any incidental, consequential or special (including punitive or multiple) damages.

All Raymarine products sold or provided hereunder are merely aids to navigation. It is the responsibility of the user to exercise discretion and proper navigational skill independent of any Raymarine equipment.

Raymarine

Factory Service Centers

United States of America

Raymarine Inc
22 Cotton Road, Unit D
Nashua, NH 03063-4219, USA
Telephone: +1 603 881 5200
Fax: +1 603 864 4756
www.raymarine.com

Sales & Order Services

Telephone: +1 800 539 5539 Ext. 2333 or
+1 603 881 5200 Ext. 2333

Technical Support

Telephone: +1 800 539 5539 Ext. 2444 or
+1 603 881 5200 Ext. 2444
Email: techsupport@raymarine.com

Product Repair Center

Telephone: +1 800 539 5539 Ext. 2118

UK, Europe, Middle East, Far East

Raymarine Ltd
Anchorage Park, Portsmouth
PO3 5TD, England
Telephone: +44 (0)23 9269 3611
Fax: +44 (0)23 9269 4642
www.raymarine.com

Customer Support

Telephone: +44 (0)23 9271 4713
Fax: +44 (0)23 9266 1228
Email: techsupport@raymarine.com

Stick barcode label here

Purchased from

Purchase date

Dealer address

Installed by

Installation date

Commissioned by

Commissioning date

Owner's name

Mailing address

This portion should be completed and retained by the owner.